



# Montage-, Bedienungs- und Wartungsanleitung

en	ASSEMBLY, USER AND MAINTENANCE INSTRUCTIONS
fr	NOTICE DE MONTAGE, D'UTILISATION ET D'ENTRETIEN
it	ISTRUZIONI DI MONTAGGIO, USO E MANUTENZIONE

## ABENTEUERSCHAUKEL

Art.-Nr. 816.2002.00.00

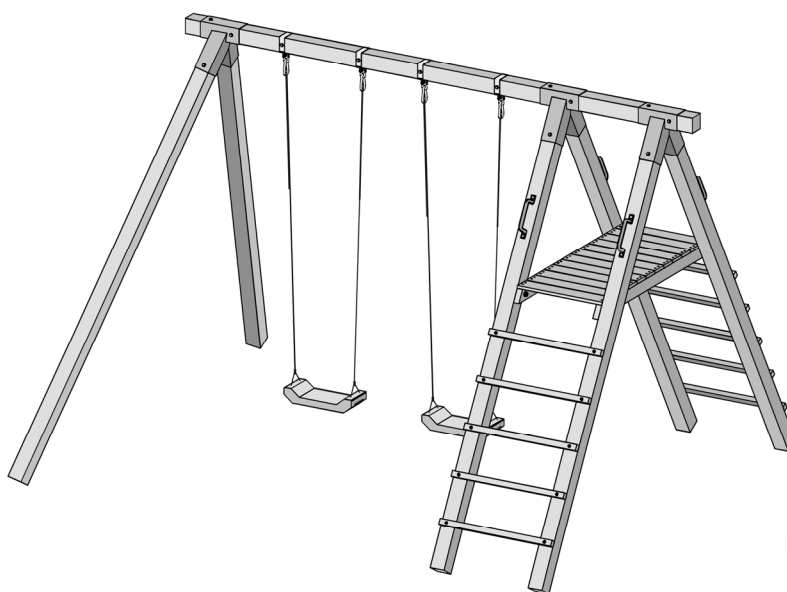

**Achtung! Dieses Spielgerät ist nur für den Hausgebrauch bestimmt!**

**Die Benutzung ist nur unter unmittelbarer Aufsicht von Erwachsenen zulässig!**

**Achtung! Nicht geeignet für Kinder unter 36 Monaten, keine spezielle Maßnahme für Kleinkinder vorgesehen! Sturzgefahr!**





**Achtung! Nur für Kinder ab 3 bis 14 Jahren geeignet!**



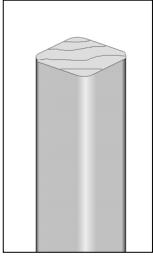
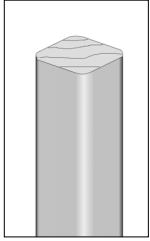
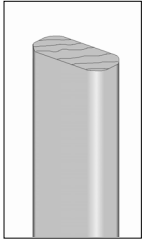
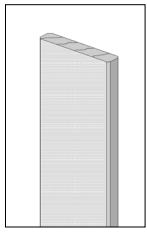
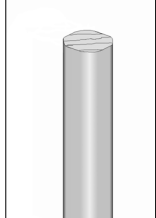
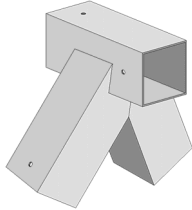

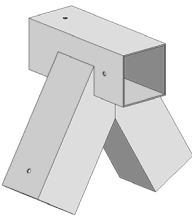
**Achtung! max. Benutzungsgewicht: 200kg**

- In regelmäßigen Abständen müssen die Verschraubungen überprüft und nachgezogen werden!
- Das Spielgerät muss mit geeigneten Mitteln am Boden verankert werden!

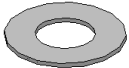
Stand: 2103

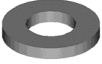
Pos	Bild	Abmessung	Stück
①		90/90/2700	6
②		90/90/3300	1
③		34/72/1280	2
④		18,5/96/550	12
⑤		32/34/730	10
⑥			1

Pos	Bild	Abmessung	Stück
7			2
8			2
9		HINWEIS: Zur leichteren Montage auf dem Querbalken ist die Schlossschraube zu entfernen und der Bügel etwas aufzubiegen.	4
M1		M8 x 70	4
M2		M8 x 60	16
M3		M8	4

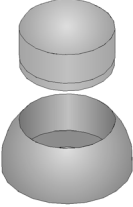
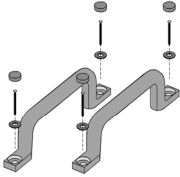
Pos	Bild	Abmessung	Stück
M4		M8	16
M5		6,0 x 60	20
M6		4,0 x 60	8
M7		4,0 x 40	50
M8		-	4
M9			2

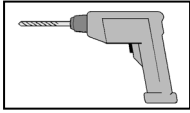
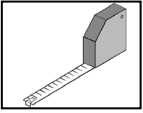

1

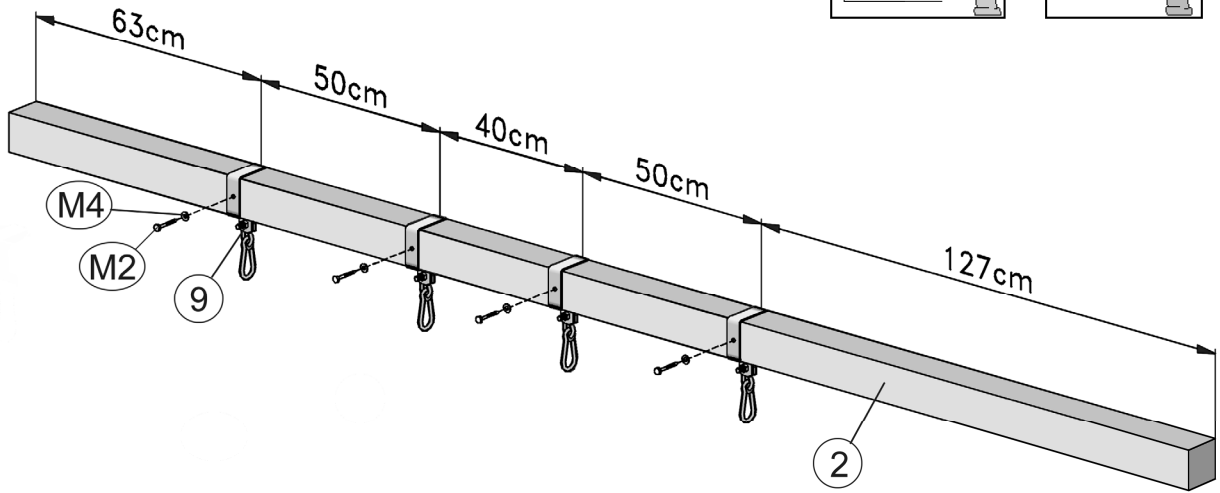
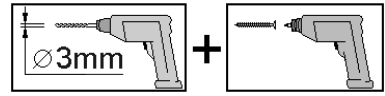

2

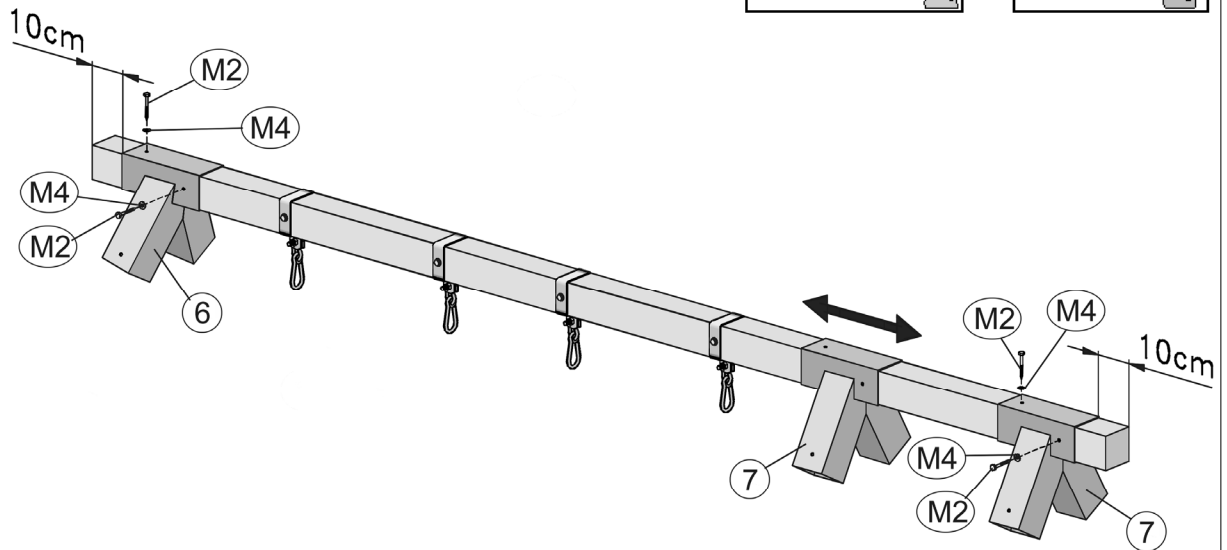
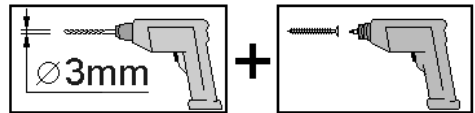

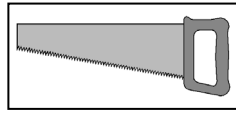
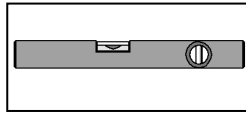
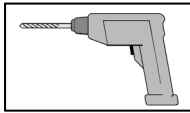
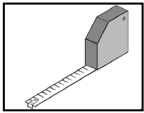

**3**

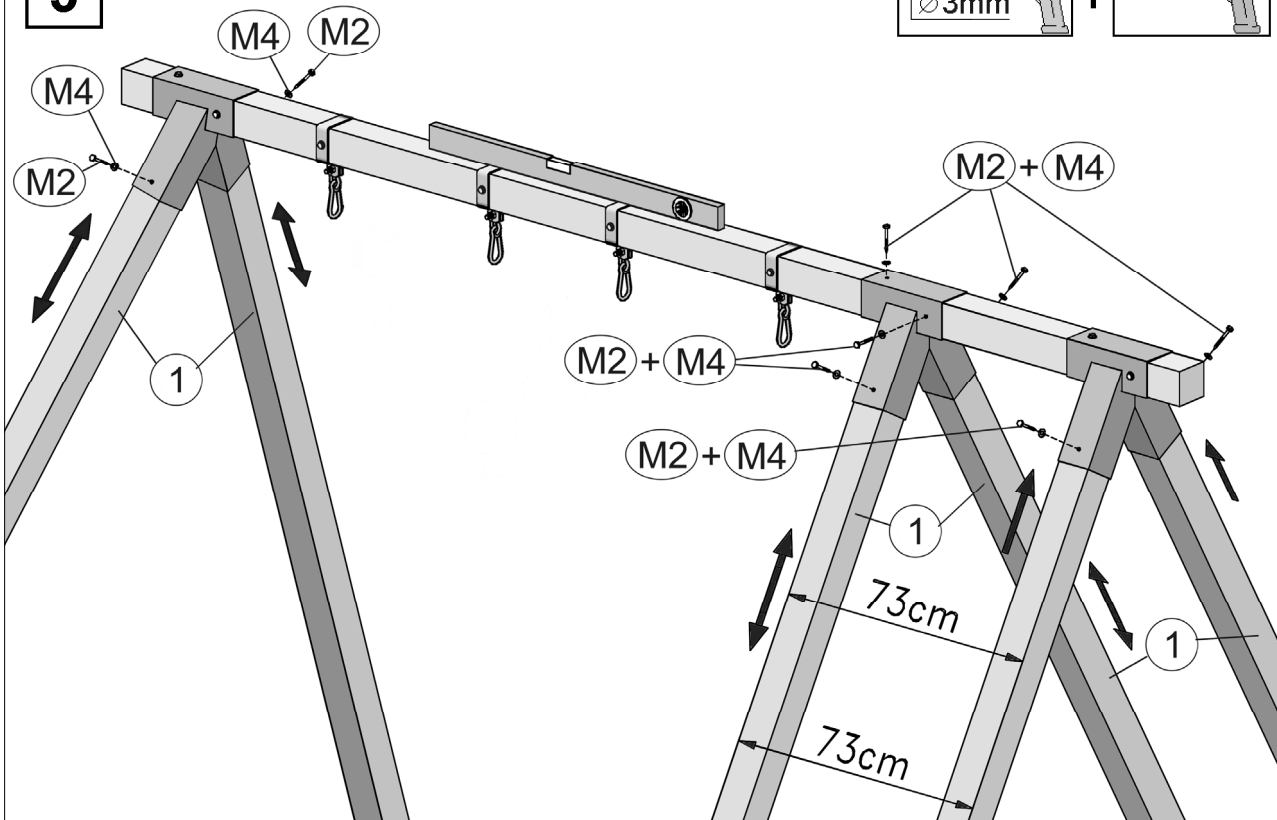
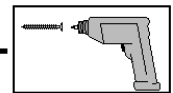
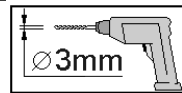

**4**

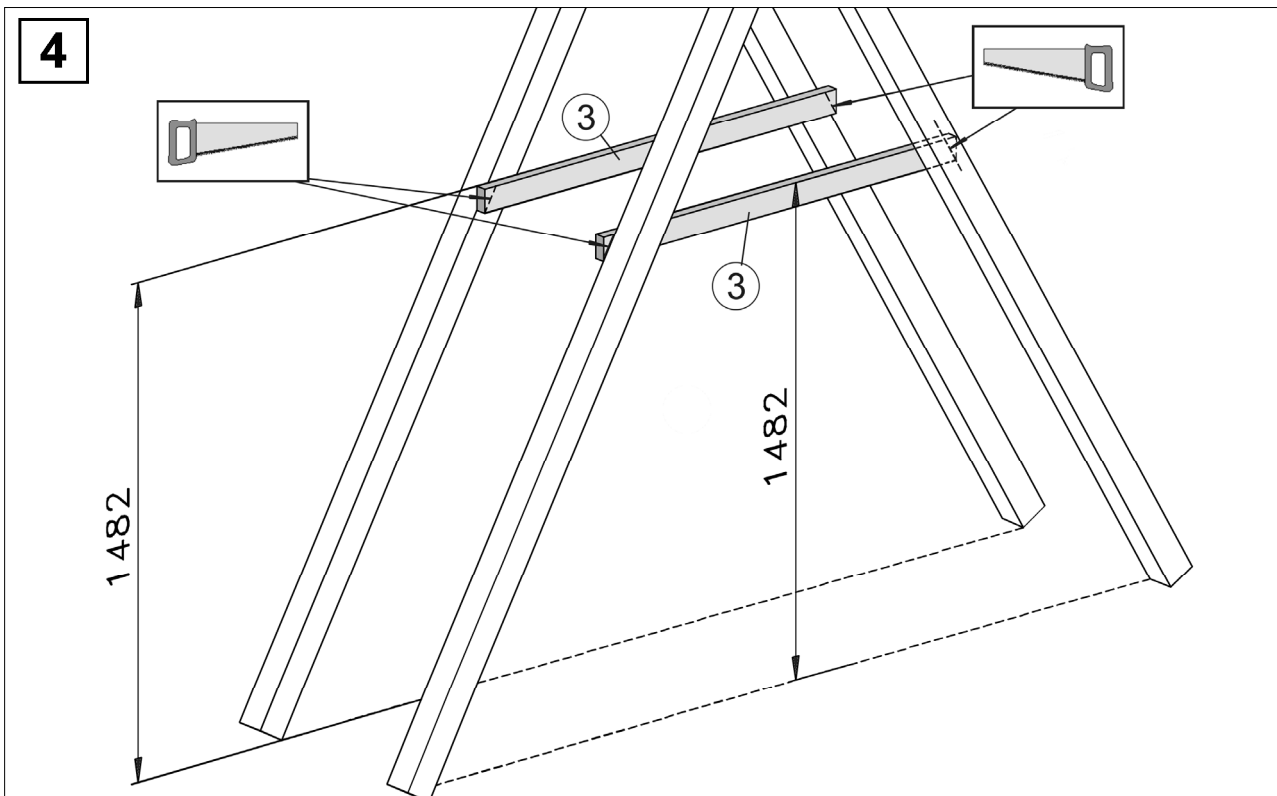
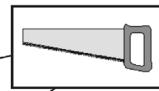
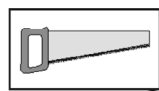

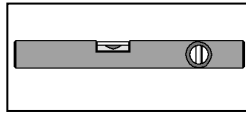
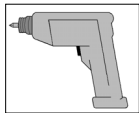
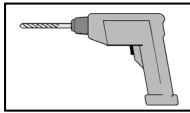
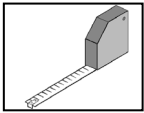

5

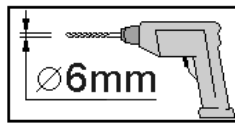
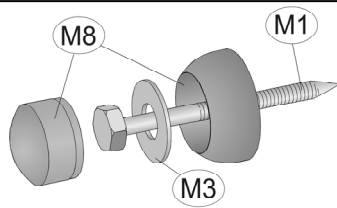

+



M6

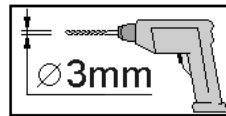

+

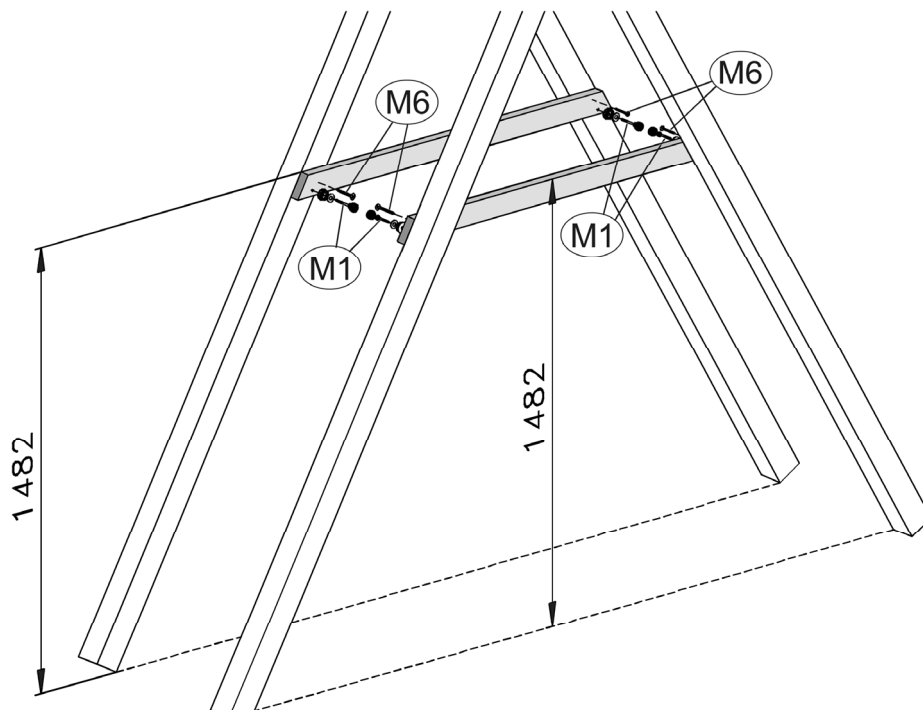
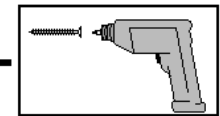

6

2x (M7)

ca. 4mm

2x (M7)

12x (4)

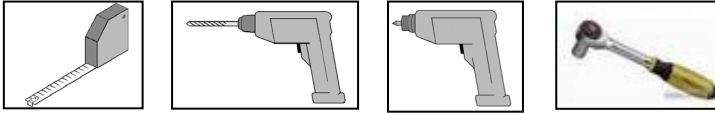

**7**

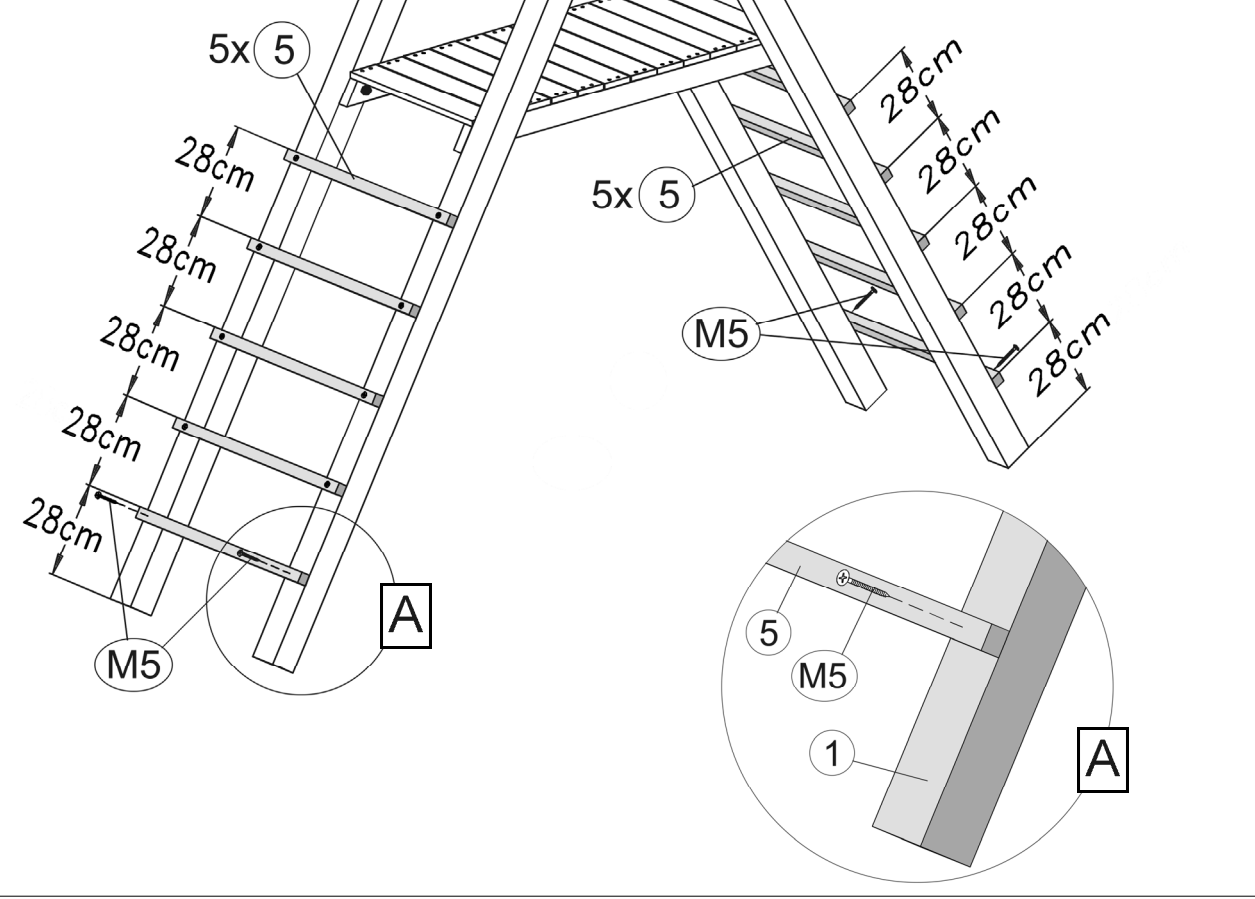
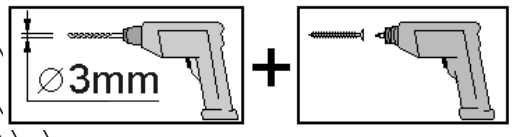

**8**

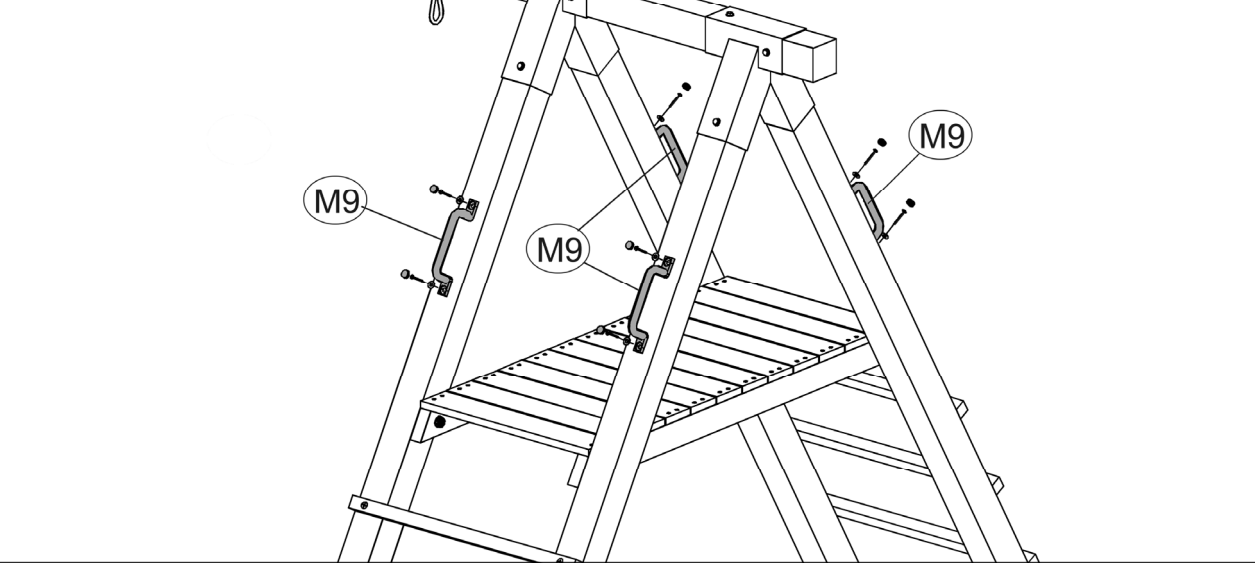











weka Holzbau GmbH, Johannesstr. 16  
D-17034 Neubrandenburg  
Tel.: 0395 42908-0  
Fax: 0395 42908-83  
EMail: [Info@weka-Holzbau.com](mailto:Info@weka-Holzbau.com)

**MA Art.-Nr.: 800.0286.10.14**