

# AUFBAUANLEITUNG „HighBoard 160“

- Ⓜ GB Assembly manual for “HighBoard 160“
- Ⓜ FR Notice de montage du “HighBoard 160“
- Ⓜ NL Opbouwbeschrijving voor “HighBoard 160“
- Ⓜ ES Instrucciones de montaje de “HighBoard 160”
- Ⓜ IT Istruzioni di montaggio “HighBoard 160”
- Ⓜ DK Monteringsvejledning for “HighBoard 160”

For further languages please go to: [www.biohort.com/downloads](http://www.biohort.com/downloads)



# WICHTIGE PUNKTE FÜR DEN AUFBAU!



## VORLIEGENDE AUFBAUANLEITUNG ZEIGT DEN ZUSAMMENBAU VON HIGHBOARD „160“. FÜR EINIGE MONTAGESCHRITTE BENÖTIGEN SIE EINEN HELFER.

- GB** Important details regarding assembly! This assembly manual shows the erection of the HighBoard size "160". For several assembly steps additional assistance of one person will be required.
- FR** Points importants lors du montage! Cette notice de montage décrit l'assemblage du produit HighBoard taille « 160 ». Pour certaines étapes, demandez l'aide d'une ou deux personnes.
- NL** Deze montage instructies hebben betrekking op de opbouw van de HighBoard grootte 160. Bij enkele stappen tijdens de opbouw heeft u een 2e persoon nodig.
- ES** Notas importantes para el montaje: Estas instrucciones muestran el montaje del arcón HighBoard en tamaño 160. Es recomendable realizar el montaje entre dos personas.
- IT** Indicazioni importanti per il montaggio! Le seguenti istruzioni di montaggio fanno riferimento all'assemblaggio di HighBoard misura "160". Per alcune fasi di assemblaggio vi servirà qualche aiutante.
- DK** Vigtige punkter ved samling! Samlemanualen viser opsætningen af modellen HighBoard str. "160". Ved flere punkter af opsætningen er yderligere hjælp påkrævet af 1 eller 2 personer.

## VERWENDEN SIE BEI DER MONTAGE ARBEITSHANDSCHUHE! UM KRATZER ZU VERMEIDEN, VERWENDEN SIE BITTE GEEIGNETE UNTERLAGEN!

- GB** Wear working gloves! Please use a suitable underlay to avoid scratches!
- FR** Portez des gants de travail! Pour éviter les rayures, utilisez les supports appropriés!
- NL** Handschoenen gebruiken! Om krassen te voorkomen raden wij u aan er iets onder te leggen!
- ES** Utilice unos guantes de trabajo. Por favor, coloque en el suelo una base protectora adecuada para evitar posibles arañazos.
- IT** Utilizzare guanti da lavoro. Utilizzare una base adatta per evitare graffi!
- DK** Brug arbejdshandsker! Benyt venligst et passende underlag for at undgå skrammer!



## ACHTEN SIE AUF EINE STURMSICHERE BODENVERANKERUNG UND VERSPERREN SIE TÜREN/DECKEL! NICHT BEI WIND AUFBAUEN!

- GB** Please make sure the product is anchored in a storm-proof manner and lock the doors/lid! Do not assembly in windy condition!
- FR** Veillez à ce que le sol soit ancré de manière à résister aux tempêtes et verrouillez les portes/couvercles ! Ne pas procéder au montage dans des conditions venteuses !
- NL** Zorg voor een stormbestendige bodem verankering en vergrendel de deuren/deksel! Niet opbouwen in winderige omstandigheden!
- ES** Asegúrese de que el suelo cuente con un anclaje a prueba de tormentas y cierre las puertas/tapas. ¡No se instalen en condiciones de viento!
- IT** Assicuratevi che il pavimento sia ancorato a prova di tempesta e chiudete a chiave le porte/coperchio! Non montare in condizioni di vento!
- DK** Vær opmærksom på at produktet forankres stormsikkert samt at dør/låg er aflåst! Bør ikke monteres ved kraftig vind!



## WASSERWAAGEN - SYMBOL:

### Betreffendes Einbauteil mit der Wasserwaage ausrichten.

- GB** Symbol of spirit level: Align the respective parts by using the spirit level..
- FR** Symbole niveau à bulle: Lorsque ce symbole apparaît, vous devez ajuster l'élément à l'aide d'un niveau à bulle.
- NL** Waterpas - symbol: Bij montageschappen waar dit symbool bijstaat is het noodzakelijk het betreffende onderdeel waterpas in te bouwen.
- ES** Símbolo del nivelador: Indica que se debe ajustar y centrar la pieza con la ayuda de un nivelador.
- IT** Simbolo di livella a bolla d'aria: Allineare il componente in questione con l'ausilio di una livella a bolla d'aria.
- DK** Symbol for vaterpas: Juster de respektive dele ved hjælp af vaterpas.

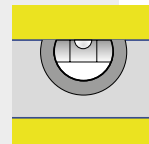

## SCHRAUBVERBINDUNGEN GRUNDSÄTZLICH ERST AM ENDE DER MONTAGE FESTZIEHEN!

- GB** Nuts not to be tightened before the end of assembly!
- FR** Ne serrer les écrous à fond qu'à la fin du montage!
- NL** Schroeven pas aan het einde van de montage vastdraaien!
- ES** En principio, no apriete fijamente las tuercas hasta que no haya terminado de montar la caseta.
- IT** I dadi devono essere serrati a fondo soltanto alla fine del montaggio!
- DK** Møtrikkerne må ikke strammes før slutningen af opsætningen!

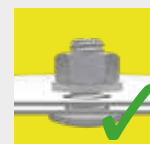

## ACHTUNG: IM SOMMER KÖNNEN IM INNENRAUM SEHR HOHE TEMPERATUREN ENTSTEHEN!

- (GB)** Attention: during the summer high temperature might arise in the interior.
- (FR)** Attention: En été la température à l'intérieur de l'abri peut être élevée!
- (NL)** Let op: in de zomer kunnen in de berging zeer hoge temperaturen bereikt worden.
- (ES)** Tenga en cuenta que en el verano las temperaturas en el interior pueden ser altas.
- (IT)** I dadi devono essere serrati a fondo soltanto alla fine del montaggio!
- (DK)** Attention: Si prega di prendere nota che in estate si possono essere temperature molto elevate all'interno.

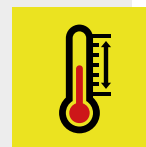

## PFLEGE UND WARTUNG

**Keine aggressiven Chemikalien wie z.B. Chlor oder Streusalz lagern! Sonnenmilch und andere Cremen mit Wasser und Seife entfernen!  
Keine scheuernden Reinigungsmittel verwenden! Ölen Sie das Schloss jährlich!**

- (GB)** Care and maintenance: Do not store aggressive substances i.e. chlorine or road salt! Remove suntan lotion or any other creams with water and rinse aid! Do not use abrasive cleaning agents! Lubricate the lock once a year!
- (FR)** Entretien et maintenance: Ne pas stocker de produits chimiques (chlore, sel, etc...) Nettoyez uniquement avec de l'eau les crèmes solaires et autres crèmes (pas de nettoyant chimique). Graissez la serrure et les charnières chaque année !
- (NL)** Onderhoud: Geen chemicaliën in de berging opslaan! Zonnebrandolie/melk en andere cremes met water en zeep verwijderen! Gebruik geen schuurmiddelen! Slot jaarlijks oliën
- (ES)** Cuidado y mantenimiento: No almacene productos químicos agresivos dentro de la caseta como por ejemplo cloro y sal antiescarcha. Evite dejar huellas o restos de cremas solares sobre la chapa. Limpie la caseta siempre con agua o un trapo húmedo. Aplique aceite en la cerradura y las bisagras una vez al año
- (IT)** Manutenzione: Non lasciare prodotti chimici aggressivi (come ad esempio cloro o sale per strade) all'interno della casetta! Rimuovere crema solare e altre creme con acqua e brillantante! Lubrificare la serratura e le cerniere a cadenza annuale!
- (DK)** Pleje og vedligeholdelse: Opbevar ikke aggressive stoffer dvs. Klor eller vejsalt! Fjern solcreme eller andre typer af creme med vand og rensningsmiddel! Brug ikke aggressive rengøringsmidler! Smør låsen årligt

## MASSTABSGETREUE ABBILDUNGEN DER ZU VERWENDENDEN SCHRAUBEN: (M 1:1)

- (GB)** Scale drawing 1:1 of the screws in use
- (FR)** Reproduction selon l'échelle 1:1.
- (NL)** Afbeelding : schaal 1:1 (ware grootte)
- (ES)** Reproducción a escala 1:1 de los tornillos que se utilizan para el montaje.
- (IT)** Immagine in scala delle viti da utilizzare!
- (DK)** Skala tegning af skrue er 1:1

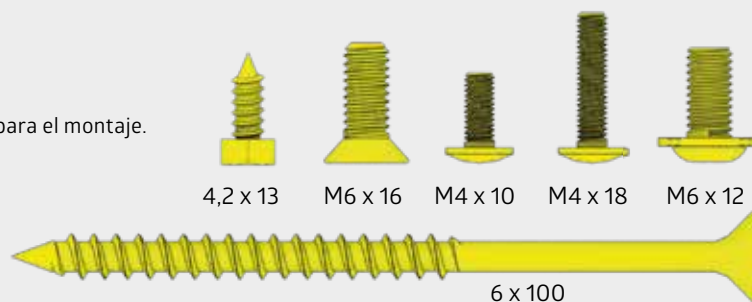

## HALTEN SIE WÄHREND DES ZUSAMMENBAUS ALLE MITGELIEFERTEN KLEINTEILE ODER VERPACKUNGSMATERIALIEN FERN VON KLEINKINDERN.

**Bauteile weisen scharfe Kanten auf oder stehen vor, achten Sie während der Montage und bei der täglichen Nutzung darauf.**

- (GB)** Keep all supplied small parts or packaging materials away from small children during assembly. Components have sharp edges or protrude, pay attention to them during assembly and during daily use.
- (FR)** Gardez toutes les petites pièces ou les matériaux d'emballage fournis hors de portée des enfants pendant le montage. Les pièces d'assemblage peuvent être tranchantes, faites-y attention lors de l'assemblage et de l'utilisation quotidienne.
- (NL)** Houd alle kleine onderdelen of verpakkingsmaterialen die worden mee geleverd uit de buurt van kleine kinderen tijdens de montage. Onderdelen hebben scherpe randen of steken uit, let op bij de montage en bij het dagelijks gebruik.
- (ES)** Mantenga todas las piezas pequeñas o materiales de embalaje suministrados lejos de los niños durante el montaje. Los componentes tienen bordes afilados o salientes, preste atención a ellos durante el montaje y durante el uso diario.
- (IT)** Tenere tutte le piccole parti o i materiali d'imballaggio forniti lontano dalla portata dei bambini durante il montaggio. I componenti hanno spigoli vivi o sporgenti, prestare attenzione ad essi durante il montaggio e durante l'uso quotidiano.
- (DK)** Hold alle leverede smådele og emballage utilgængeligt for børn under montagen. Komponenter har skarpe kanter eller stikker ud, vær opmærksom på dem under montering og under daglig brug.

## KEINE ABDECKUNG/HÜLLE FÜR DAS PRODUKT VERWENDEN!

- (GB)** Do not use a cover for the product!
- (FR)** Ne pas couvrir le produit, ne pas utiliser de housse.
- (NL)** Gebruik geen afdekhoes voor het product!
- (ES)** No utilice una cubierta/manga para el producto.
- (IT)** Non utilizzare una copertura/manica per il prodotto!
- (DK)** Produktet bør ikke tildækkes!

## OPTIONALES ZUBEHÖR - SYMBOL:

Arbeitsschritte die blau eingrahmt sind, zeigen den Einbau eines optionalen Zubehörteiles.

- (GB)** Symbol of optional accessories: Blue framed assembly steps show the installation of optional accessories.
- (FR)** Accessoires en option-Symbole: La trame entourée en bleu indique une étape avec accessoires en option. A réaliser uniquement si vous avez commandé cet accessoire.
- (NL)** Extra Toebehoor: Montagestappen met een blauwe rand betreffen de inbouw van extra toebehoor.
- (ES)** Accesorio opcional – símbolo: Los pasos de montaje que se encuentran enmarcados en azul muestran el montaje de una pieza de un accesorio opcional.
- (IT)** Simbolo per accessori opzionali: Le fasi del montaggio incorniciate in colore azzurro mostrano l'installazione di un accessorio opzionale.
- (DK)** Symbol for ekstra udstyr: Blåt indrammet samletrin viser installationen af ekstraudstyr



## UMGANG MIT BESCHÄDIGTEN TEILEN

Verbauen Sie keine beschädigten Teile! Falls Sie Beschädigungen feststellen, müssen diese vorab inkl. aussagekräftiger Bilder an uns gemeldet werden. Durch den Verbau gelten die Teile als akzeptiert.

- (GB)** Handling of damaged parts: Do not install damaged parts! If you note damages, they must be reported to us in advance, including meaningful pictures. The parts are considered accepted by the installation.
- (FR)** Manipulation des pièces endommagées: N'installez pas de pièces endommagées! Si vous découvrez des dommages, vous devez nous en informer à l'avance, en nous envoyant des photos significatives. Après le montage, les pièces sont considérées comme acceptées.
- (NL)** Omgaan met beschadigde onderdelen: Monteer géén beschadigde onderdelen! Als u schade ontdekt, moet dit vooraf aan ons worden gemeld, inclusief duidelijke foto's. Als u de beschadigde onderdelen toch monteert, dan heeft u hiermee het product "geaccepteerd".
- (ES)** Manejo de partes dañadas: Por favor, NO instale partes dañadas, Si descubre algún daño, debe informarnos con antelación, incluyendo fotos claras de los daños. Las piezas se consideran aceptadas si se realiza su la instalación.
- (IT)** Gestione di parti danneggiate: Non installare parti danneggiate! Se si rivela un danno, questo deve essere segnalato in anticipo per mail con materiale fotografico a supporto del reclamo. Se si procede all'installazione delle parti danneggiate, Biohort si riserva il diritto di respingere il reclamo.
- (DK)** Håndtering af beskadigede dele: Brug ikke beskadigede dele! Hvis du opdager nogen skade, skal dette rapporteres til os på forhånd, herunder meningsfulde billeder. Dele betragtes som accepteret gennem installationen. Verwenden Sie bei der Montage Arbeitshandschuhe! Um Kratzer zu vermeiden,

## 1 DECKEL - PAKET

Lid package · Colis du couvercle · Dekselpakket · Paquete de tapa · Pacchetto di coperchio · Dækselpakke

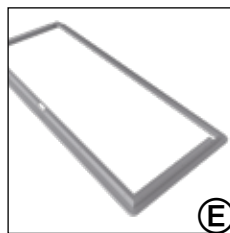
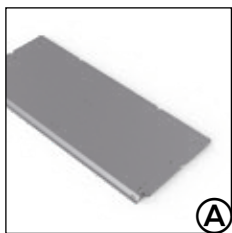

### KLEINTEILEPAKET

double door package | carton de double portes

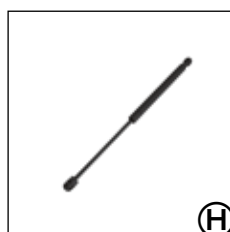
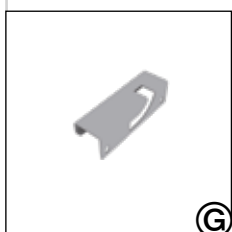

## 2 KORPUS - PAKET

Corpus package · Colis de l'ossature · Framepakket · Corpus · Corpus · Kassepakke

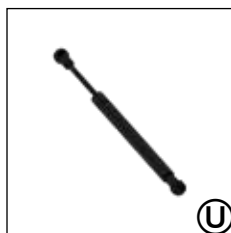
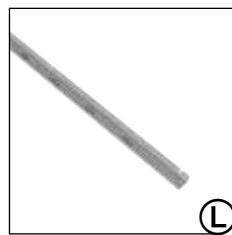
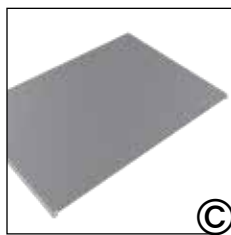
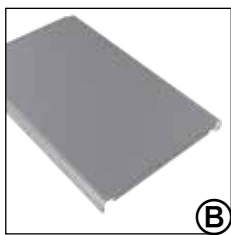

### KLEINTEILEPAKET

double door package | carton de double portes

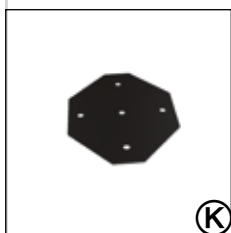

## 3 TÜR - PAKET

Tür-Paket · Doorpackage · Carton de portes · Deurpakket · Kit de puerta · Pacco porta · Dørpakke

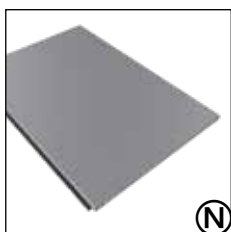

1.

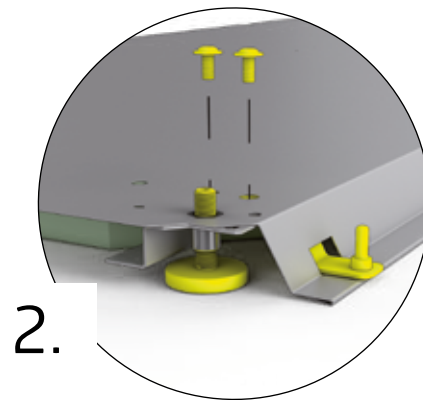
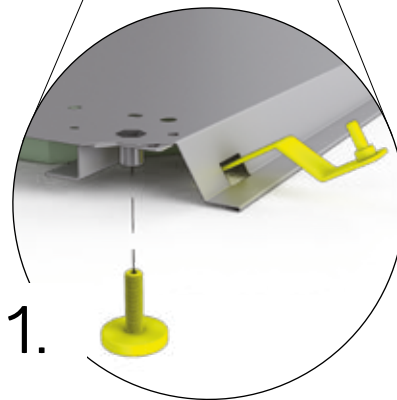
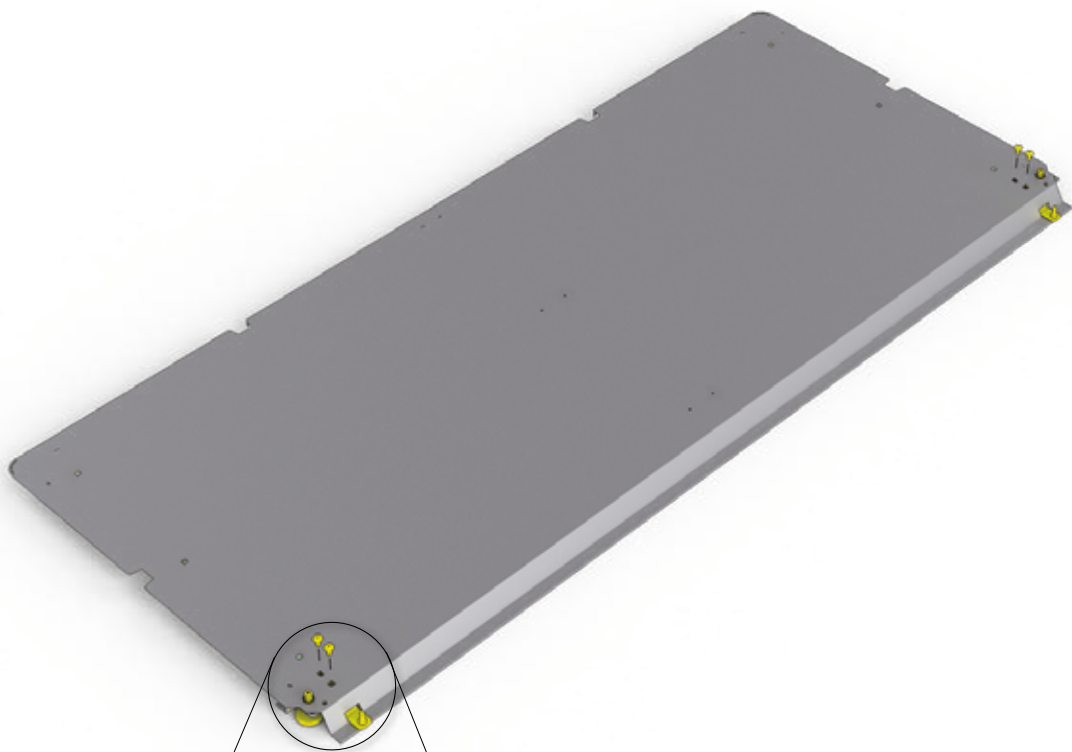

# 2.

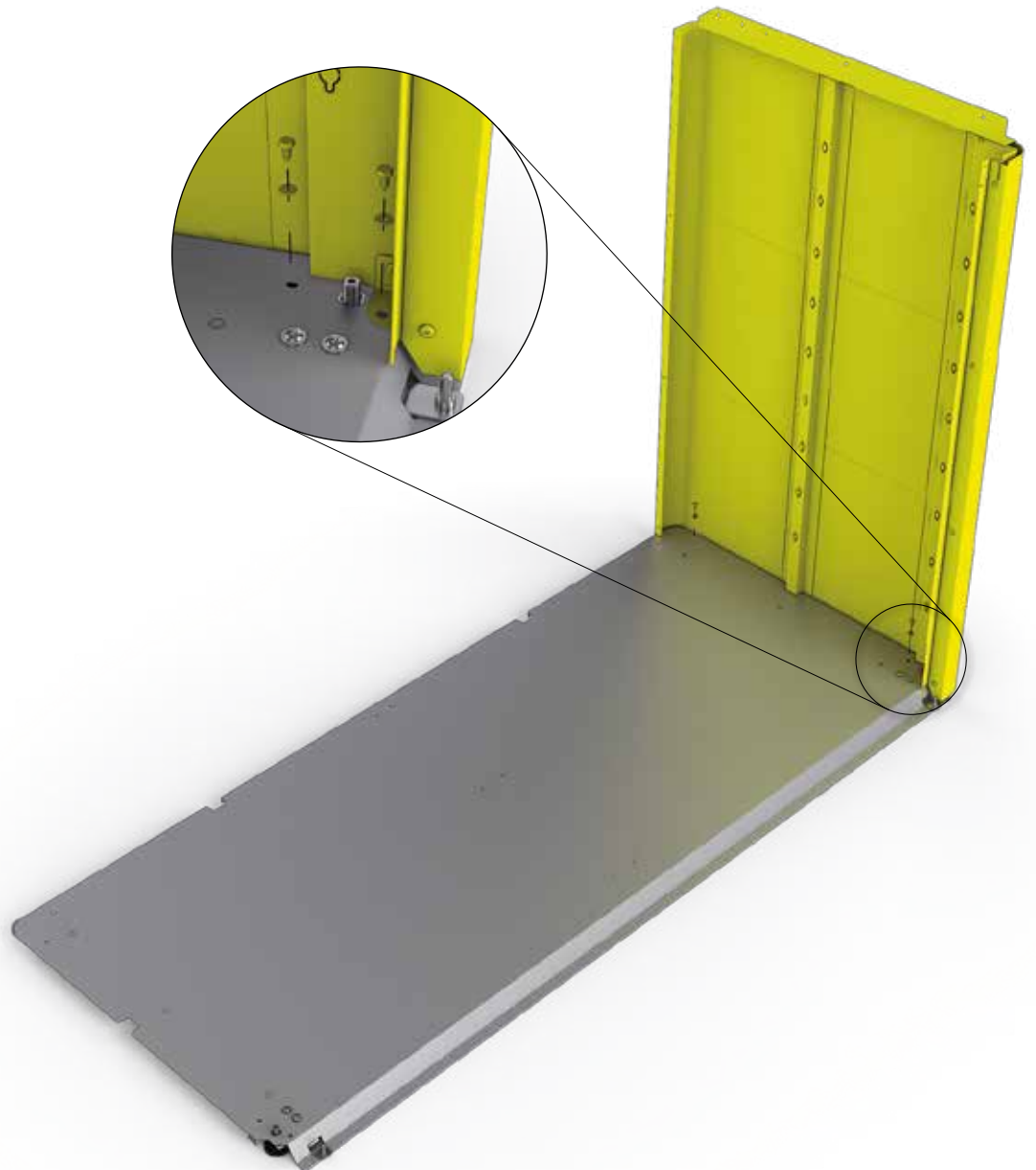
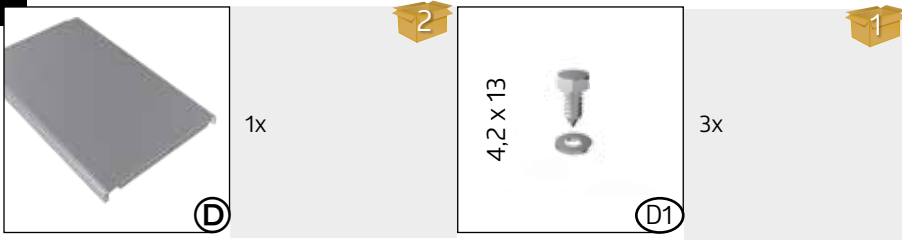

# 3.

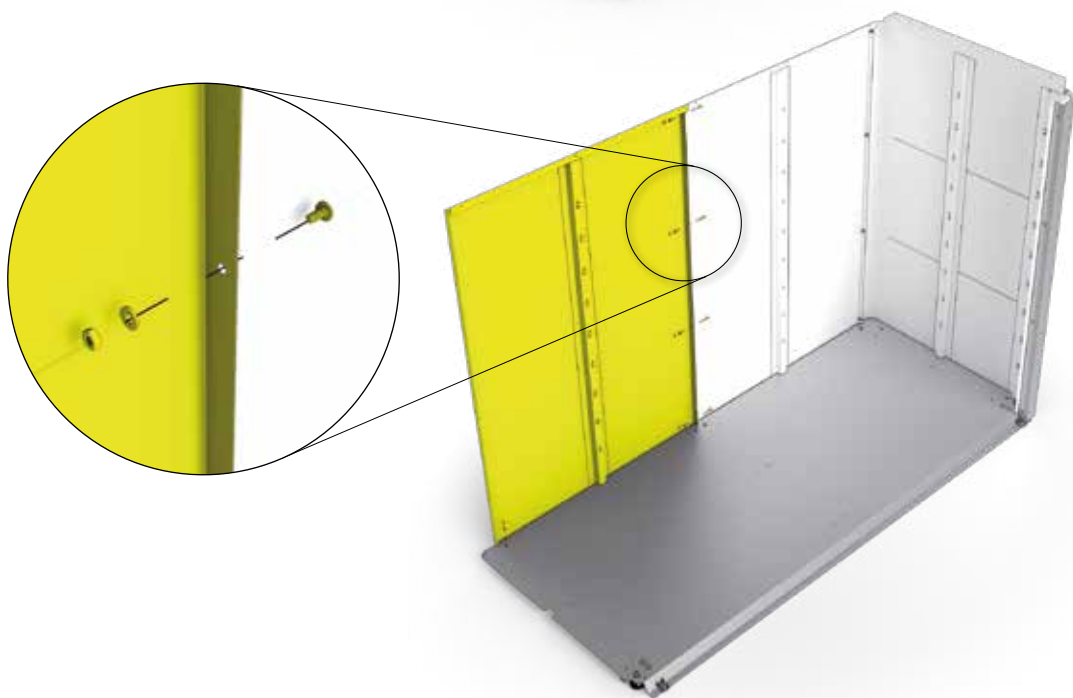
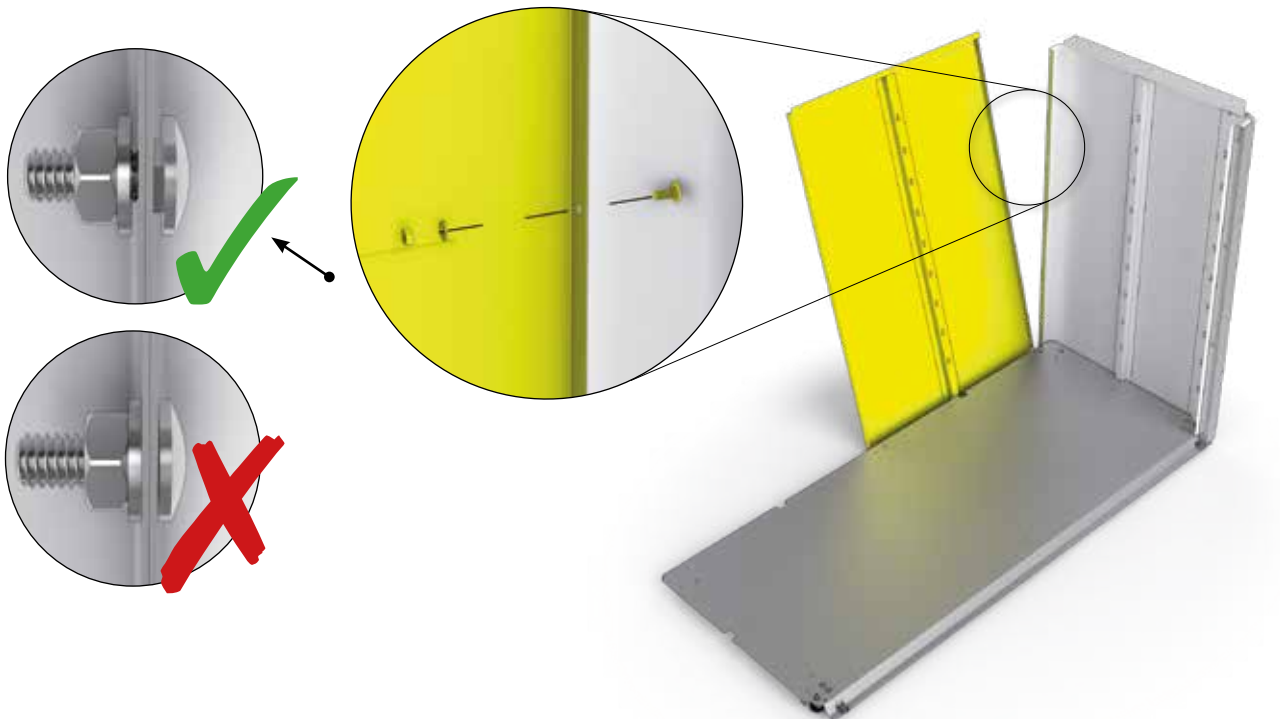
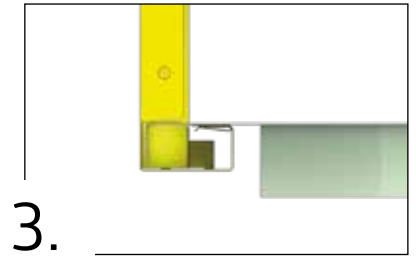
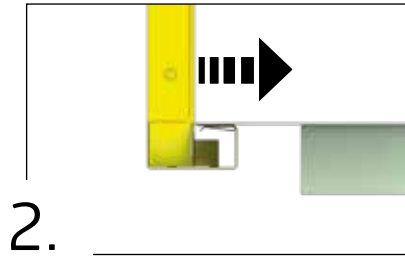
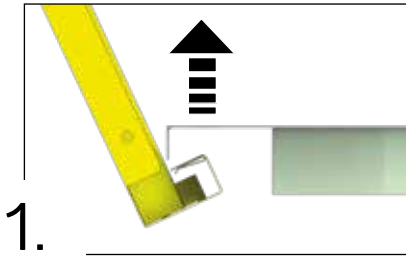
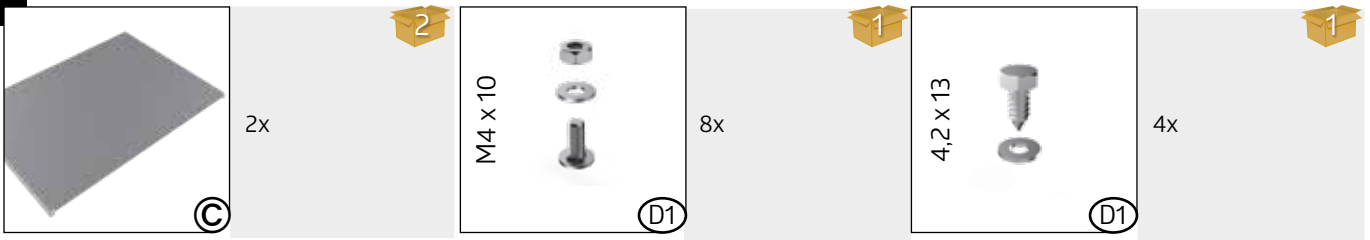



# 4.

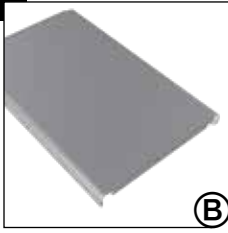

2

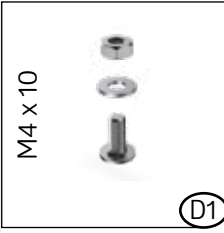

1



1

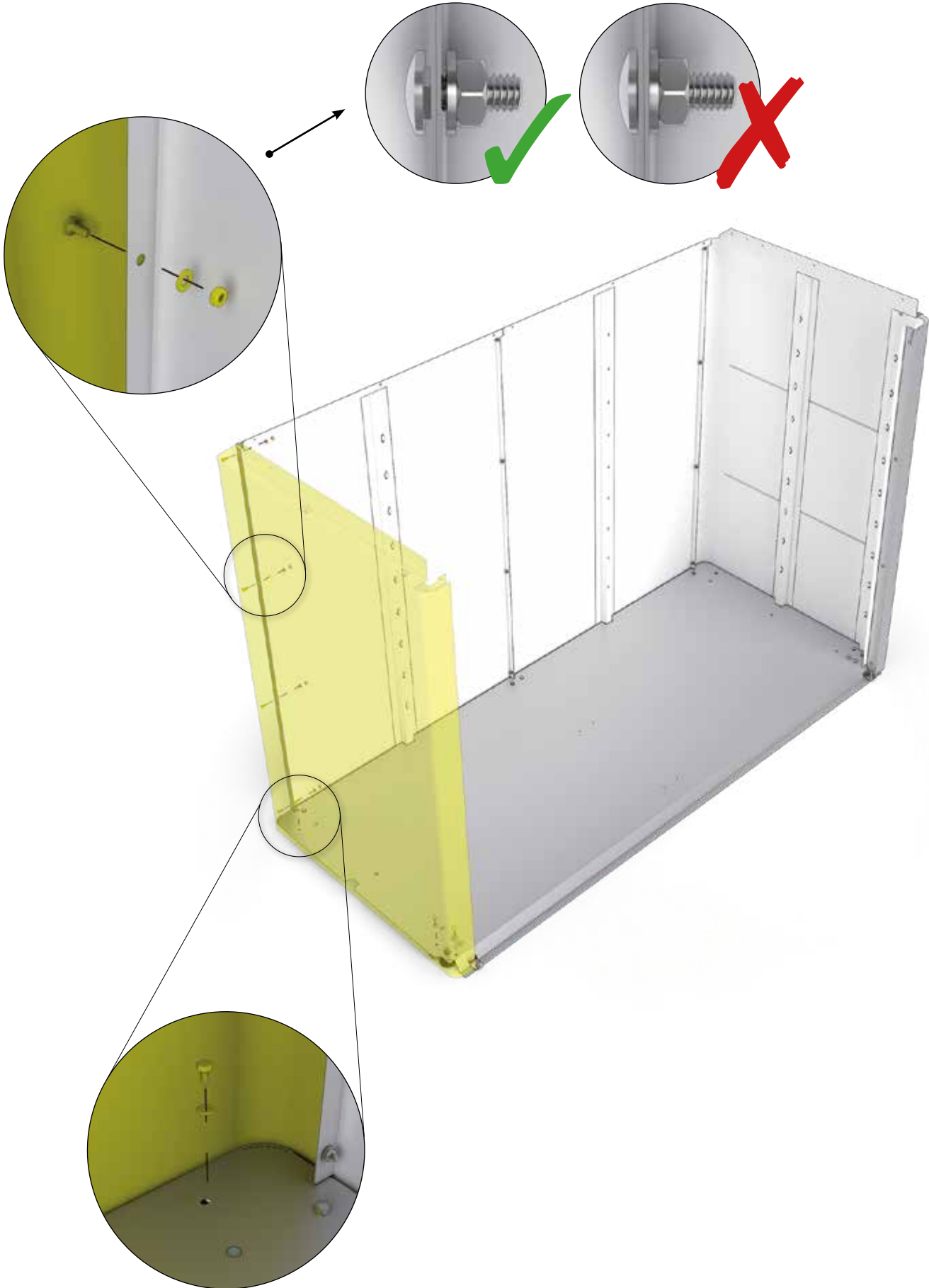

5.

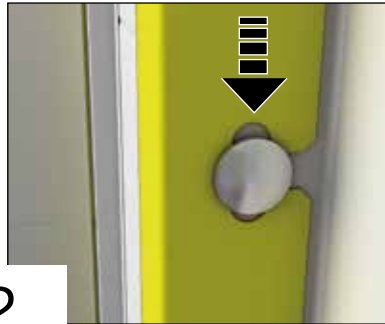
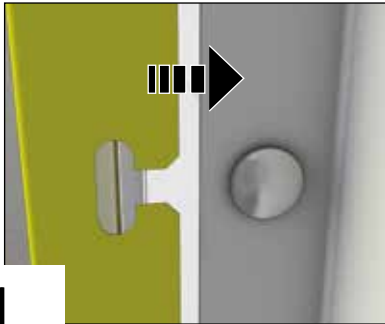
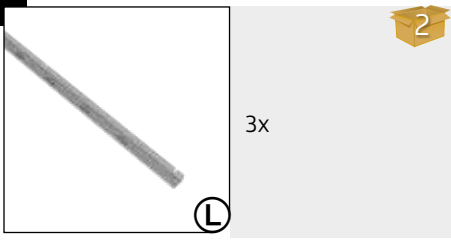

optionales Zubehör - Accessories - Accessoires - Toebehoor - Accessori - Accesorios - Ekstraudstyr

**Zwischenboden**

Intermediate floors - Sol intermédiaire - tussenbodem - Ripiano intermedio - Balda intermedia - Mellemhylde

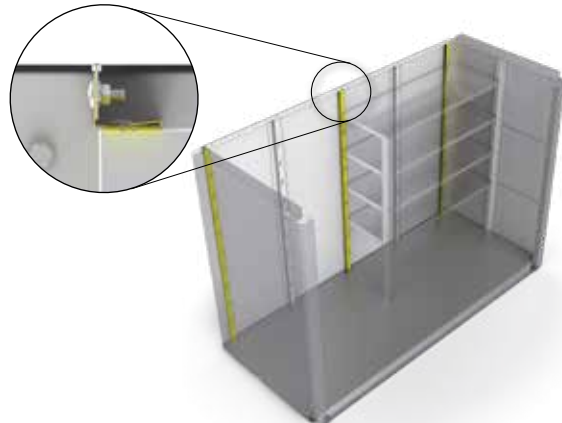
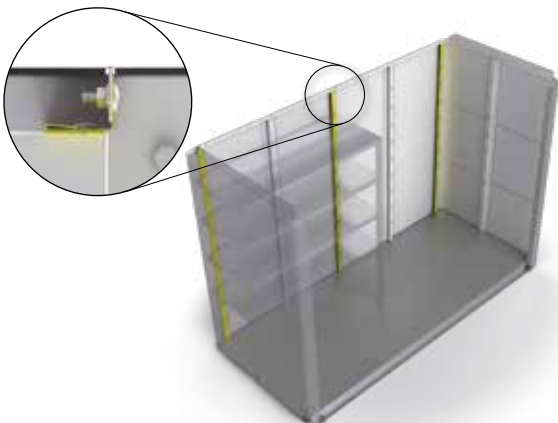

optionales Zubehör - Accessories - Accessoires - Toebehoor - Accessori - Accesorios - Ekstraudstyr

# 6.

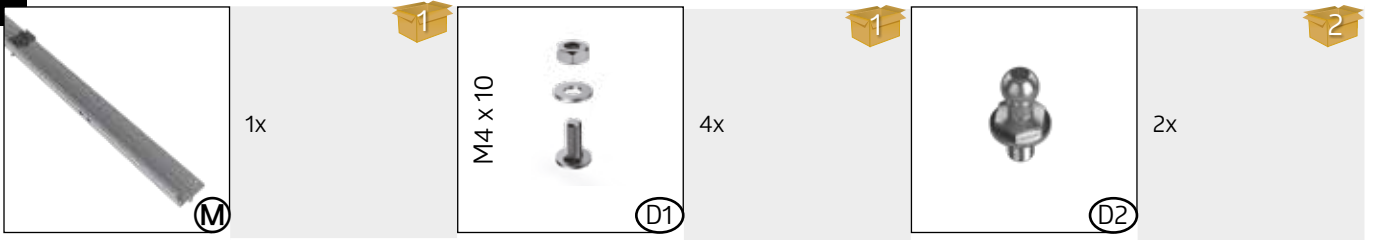

1.

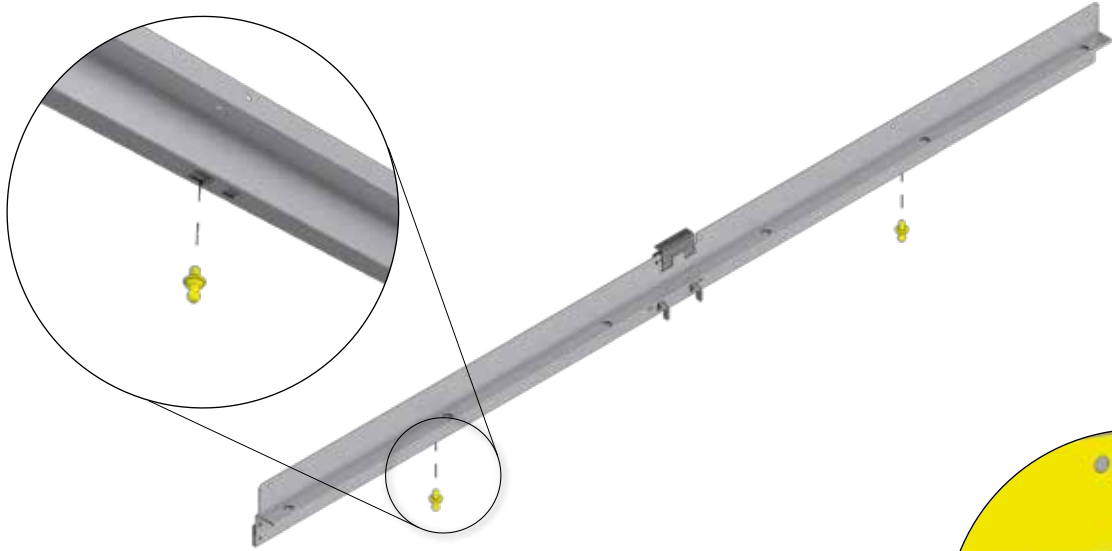

2.

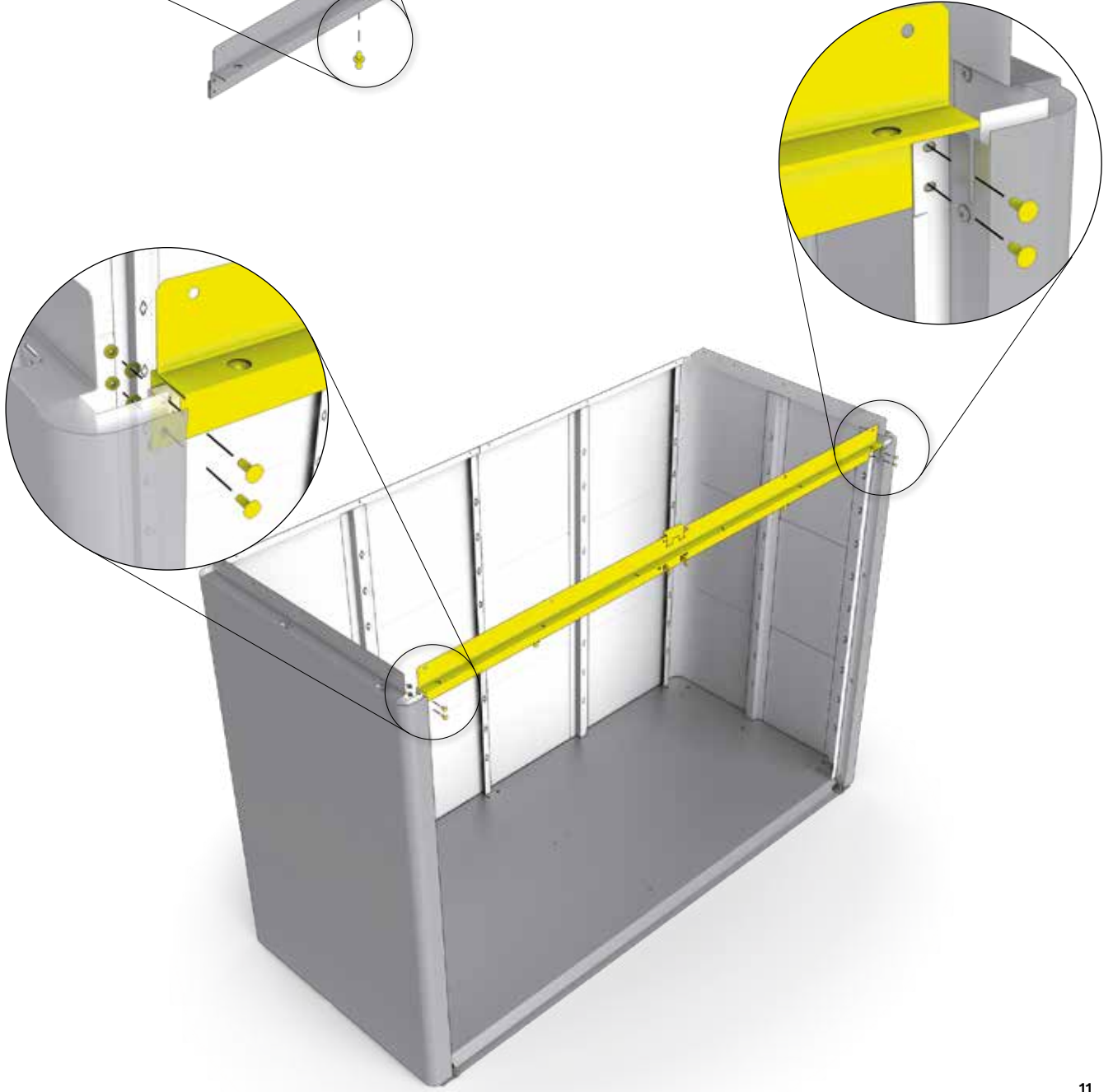



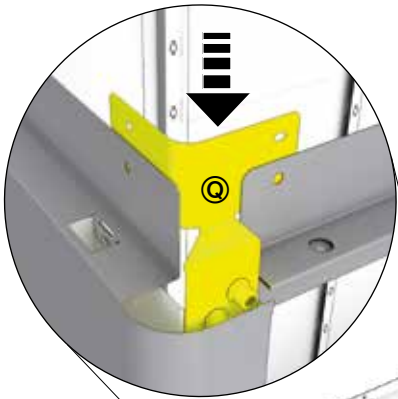
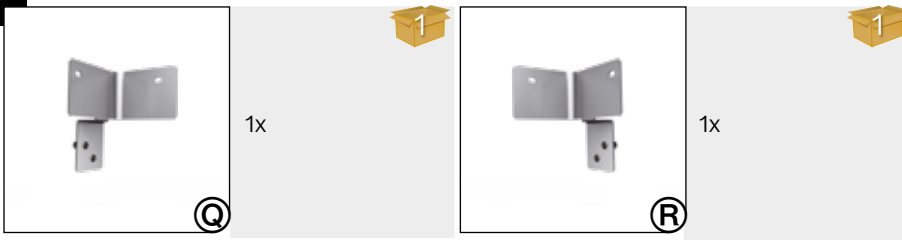



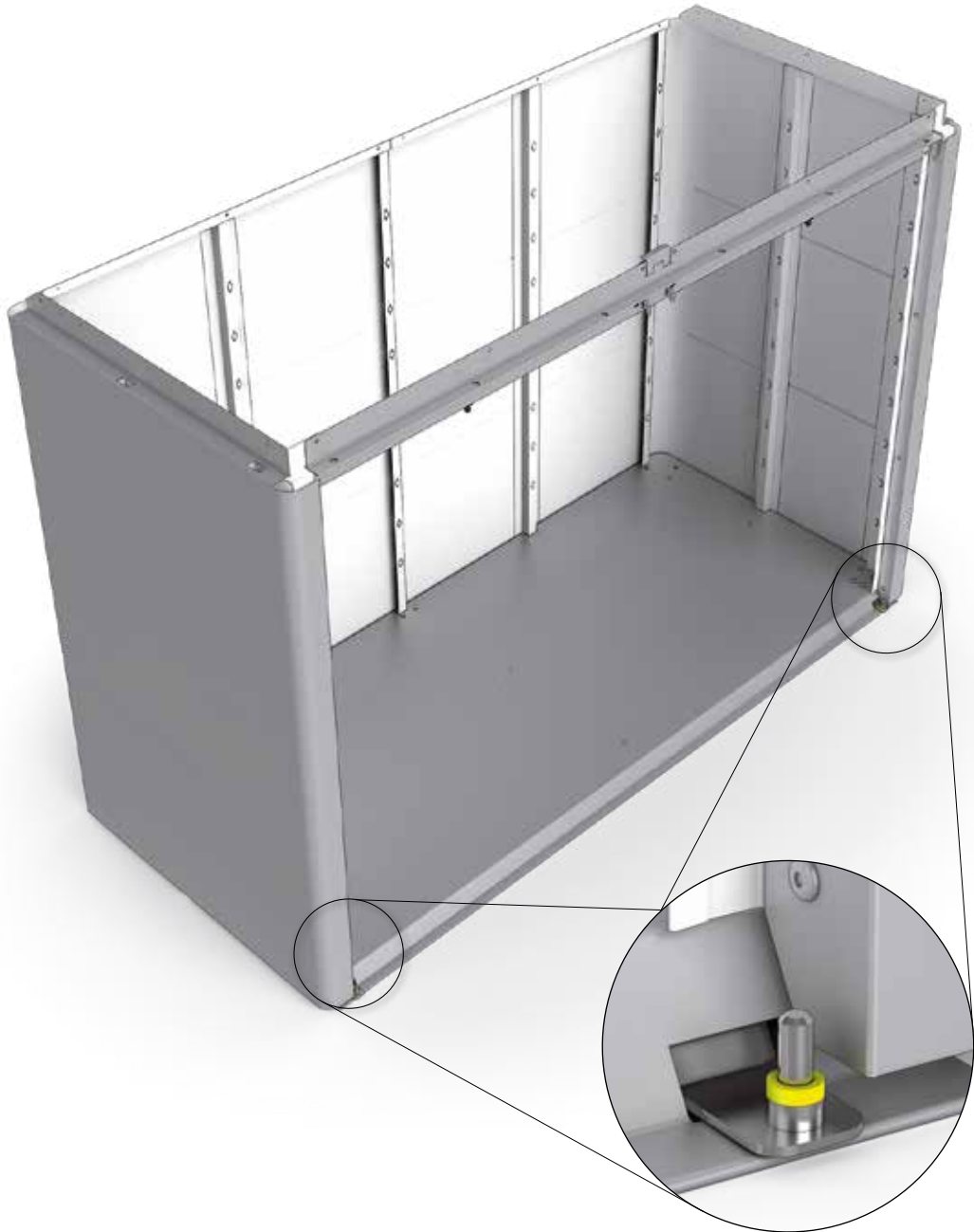
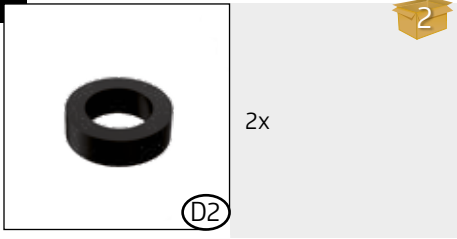

# 7.



8.



# 9.

 2x D2	 1x D2	 1x D2
 1x N	 1x O	 1x S
 1x T	 2x D2	 10x 4,2 x 13 D1

2x

1.

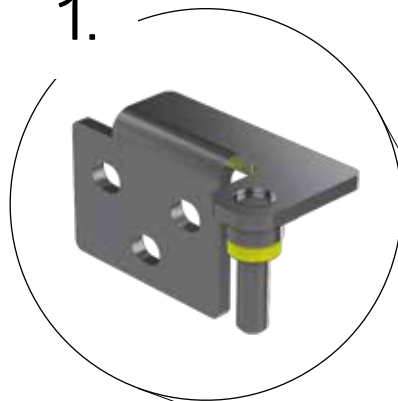

2.

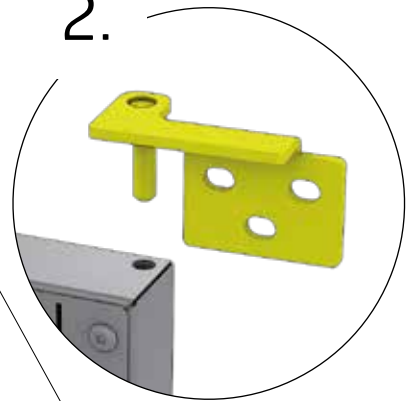

4.

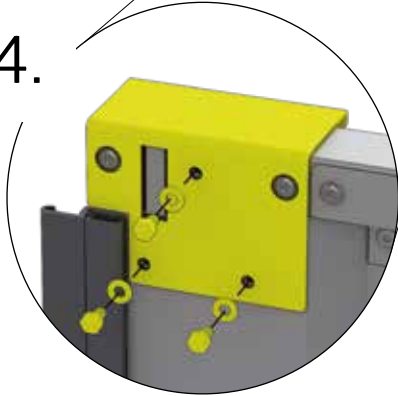

3.

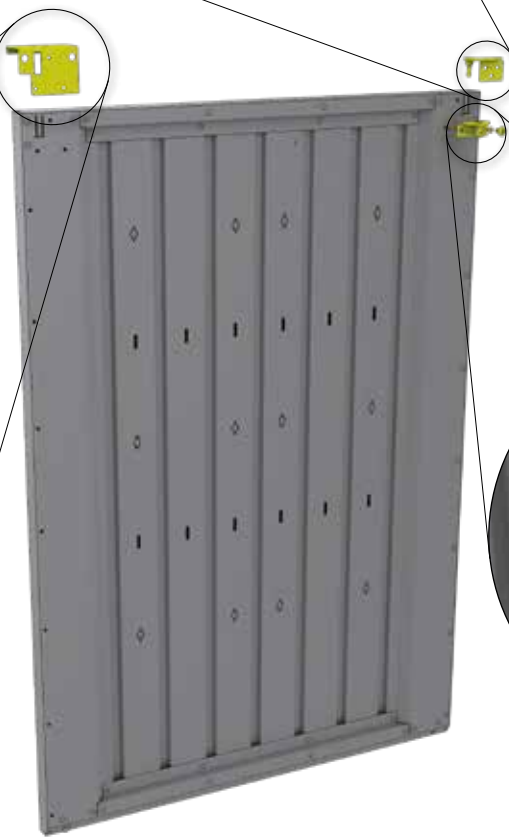
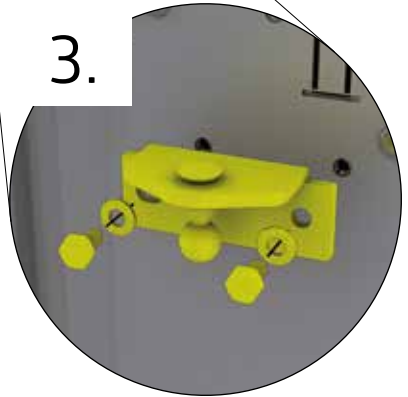

# 10.

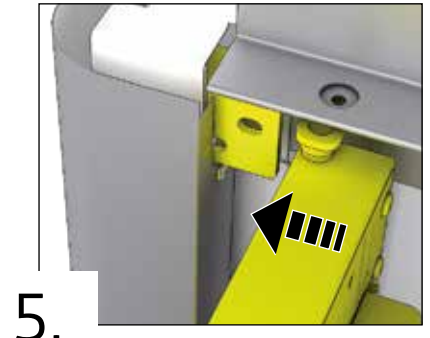
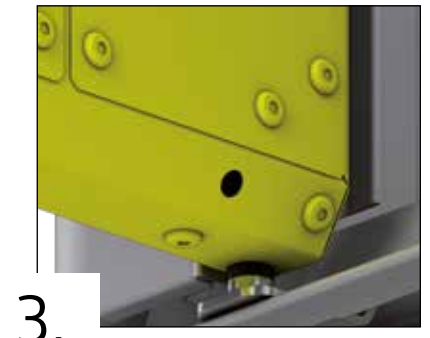
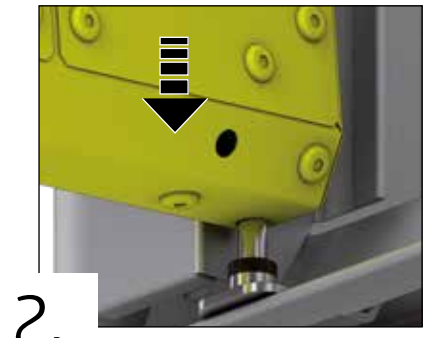
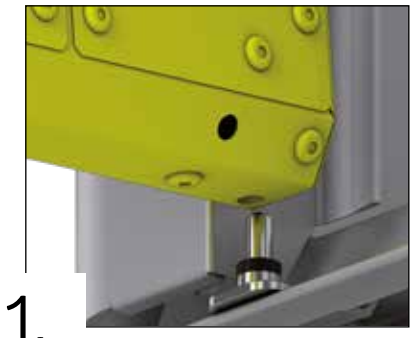
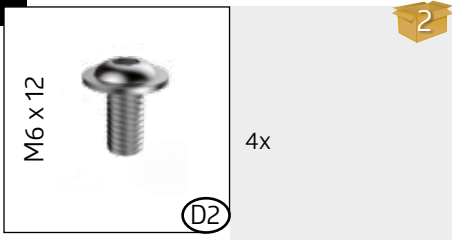

# 11.

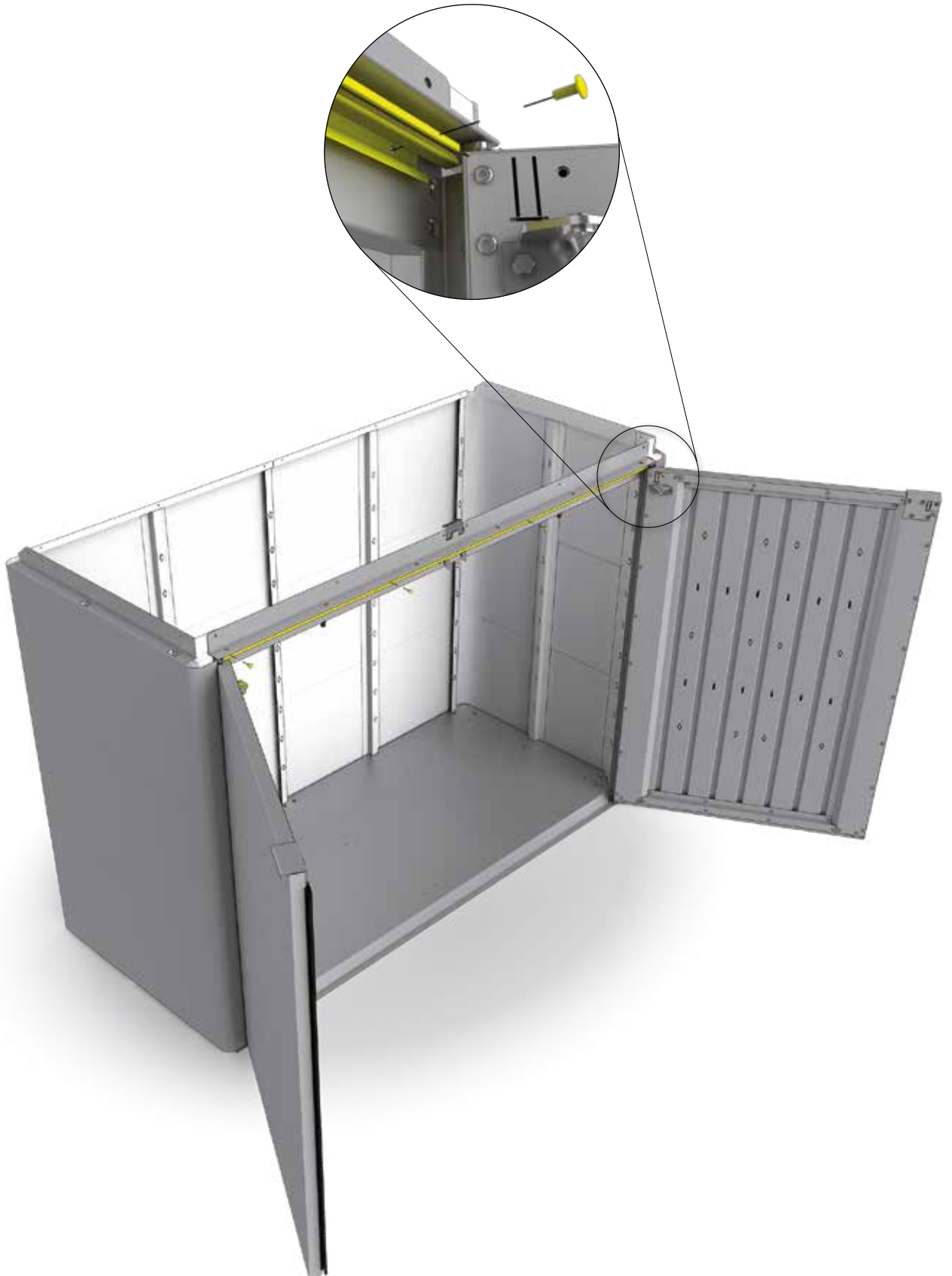



# 12.

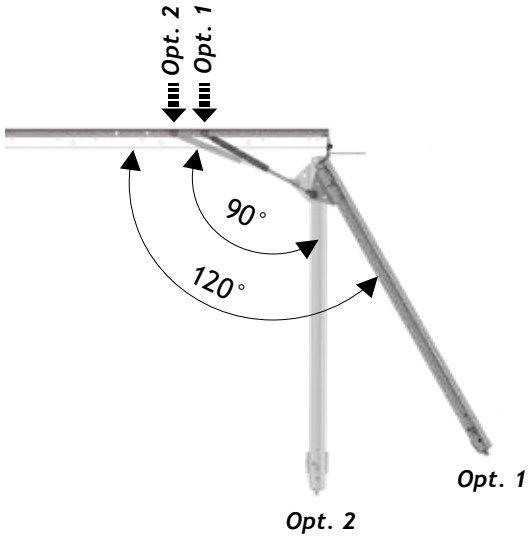
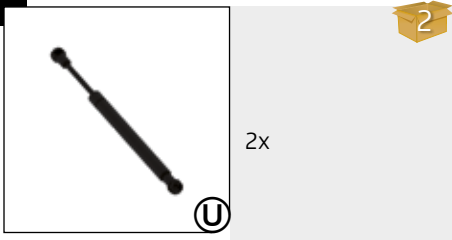

# 13.

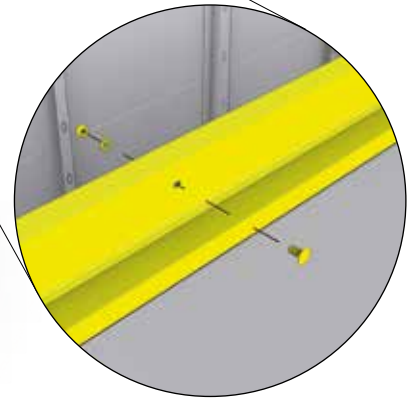
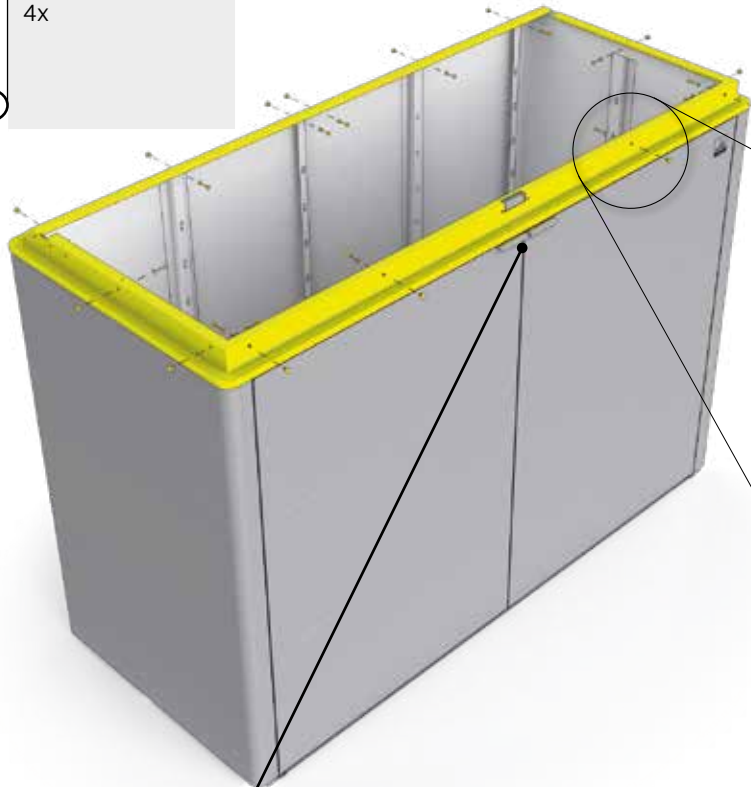

1.

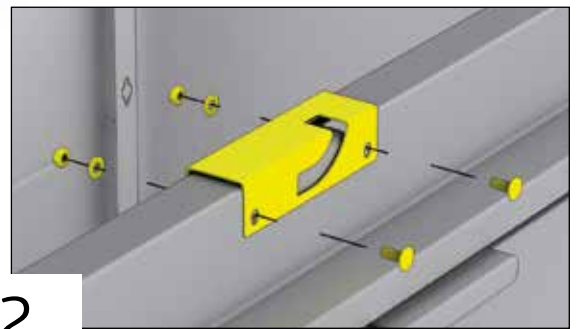

2.



**Ziehen Sie jetzt alle Schraubverbindungen fest an!**

Tighten now all nuts and connections securely! - Serrez maintenant les vis à fond! - Draai nu alle schroeven vast! - Ahora puede apretar y fijar todos los tornillos y tuercas - Adesso serrare a fondo tutti i dadi - Fastspænd nu alle bolt-/skruerforbindelser!



# 14.

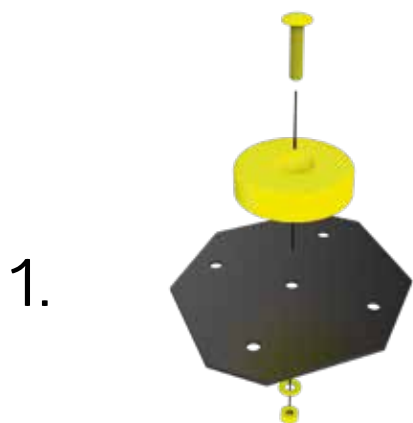
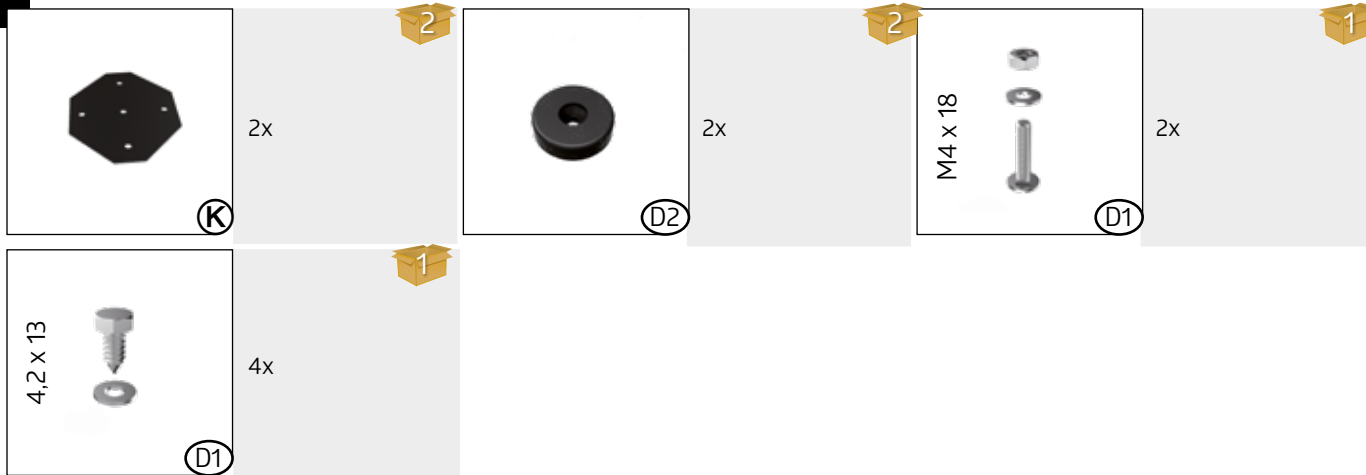

3.

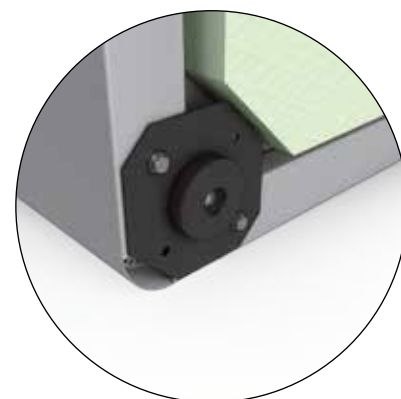
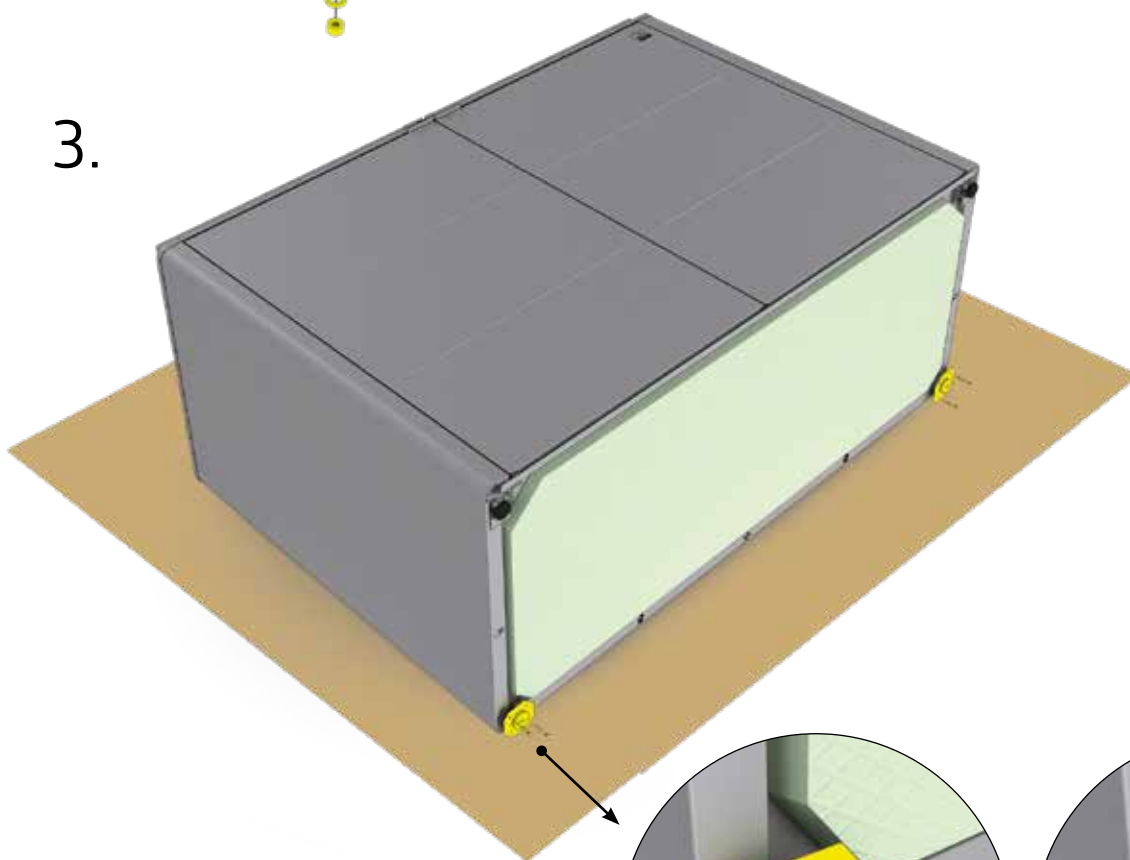

# 15.

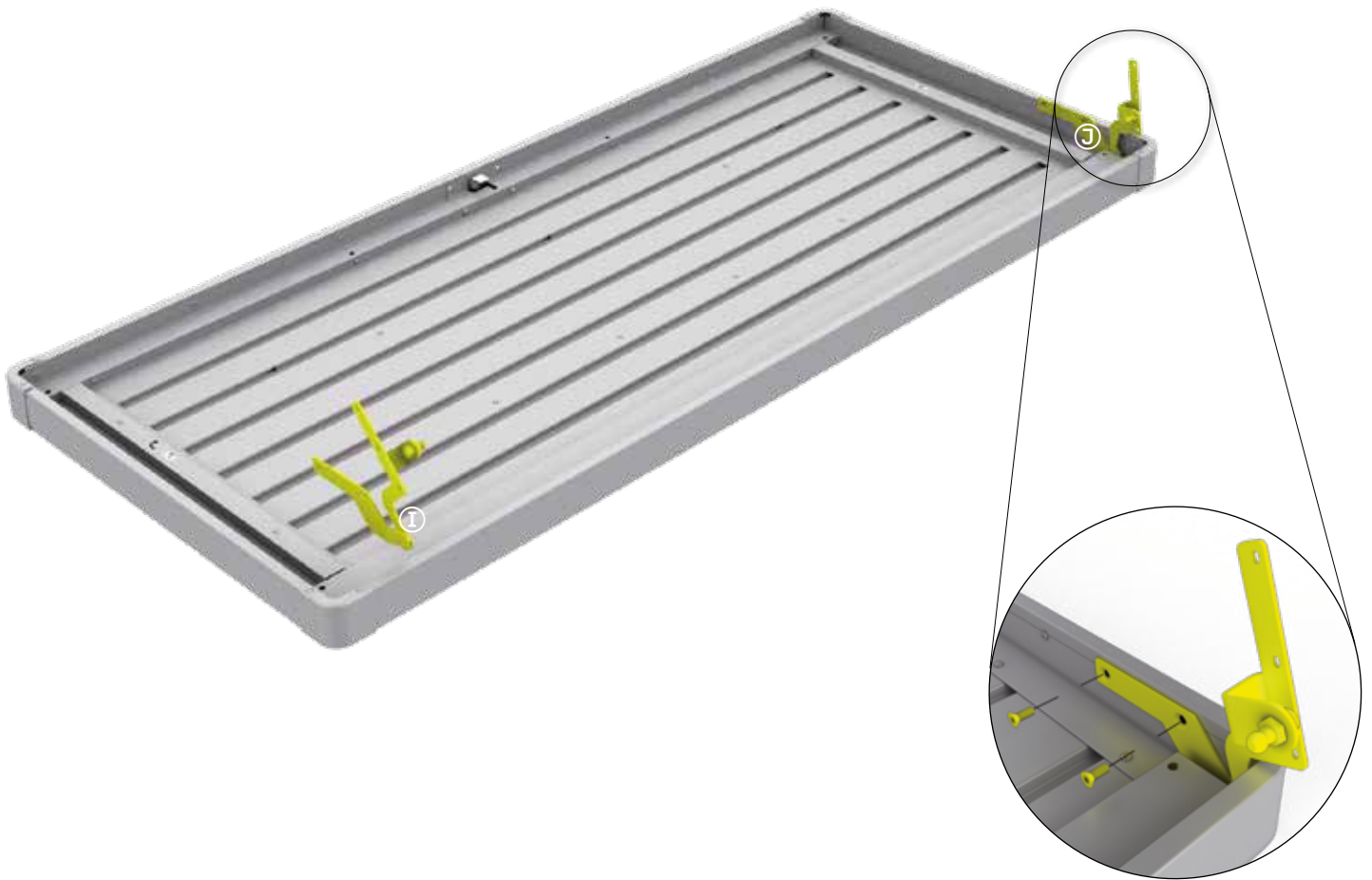
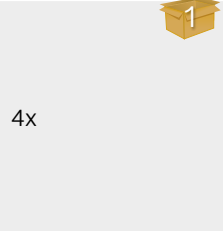
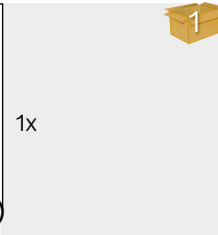
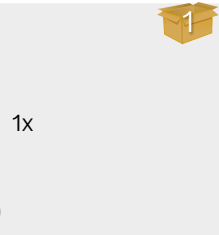

16.

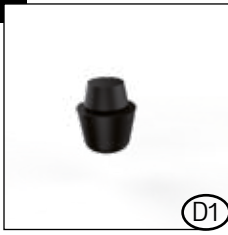

6x

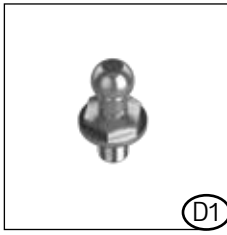

2x

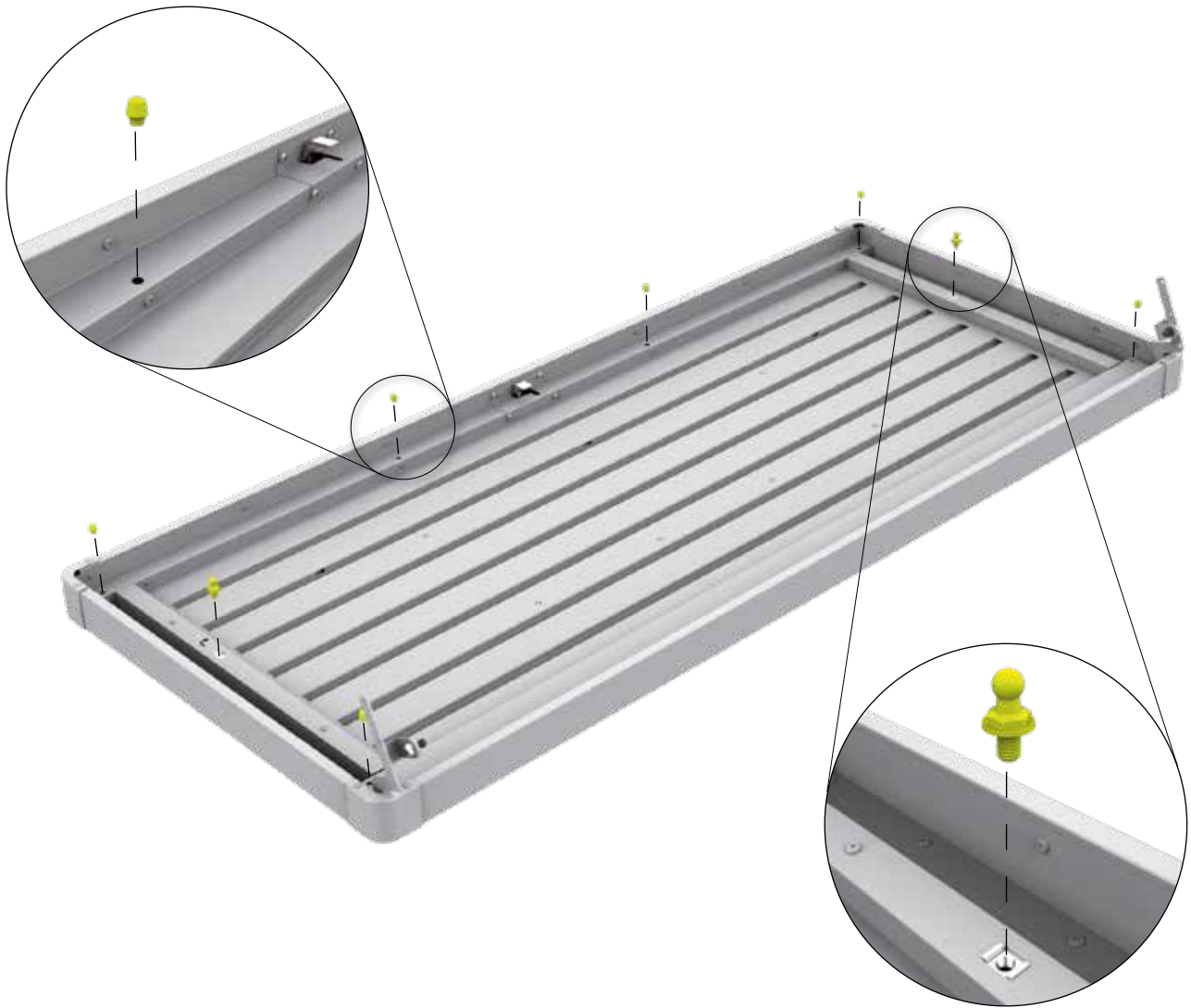

17.

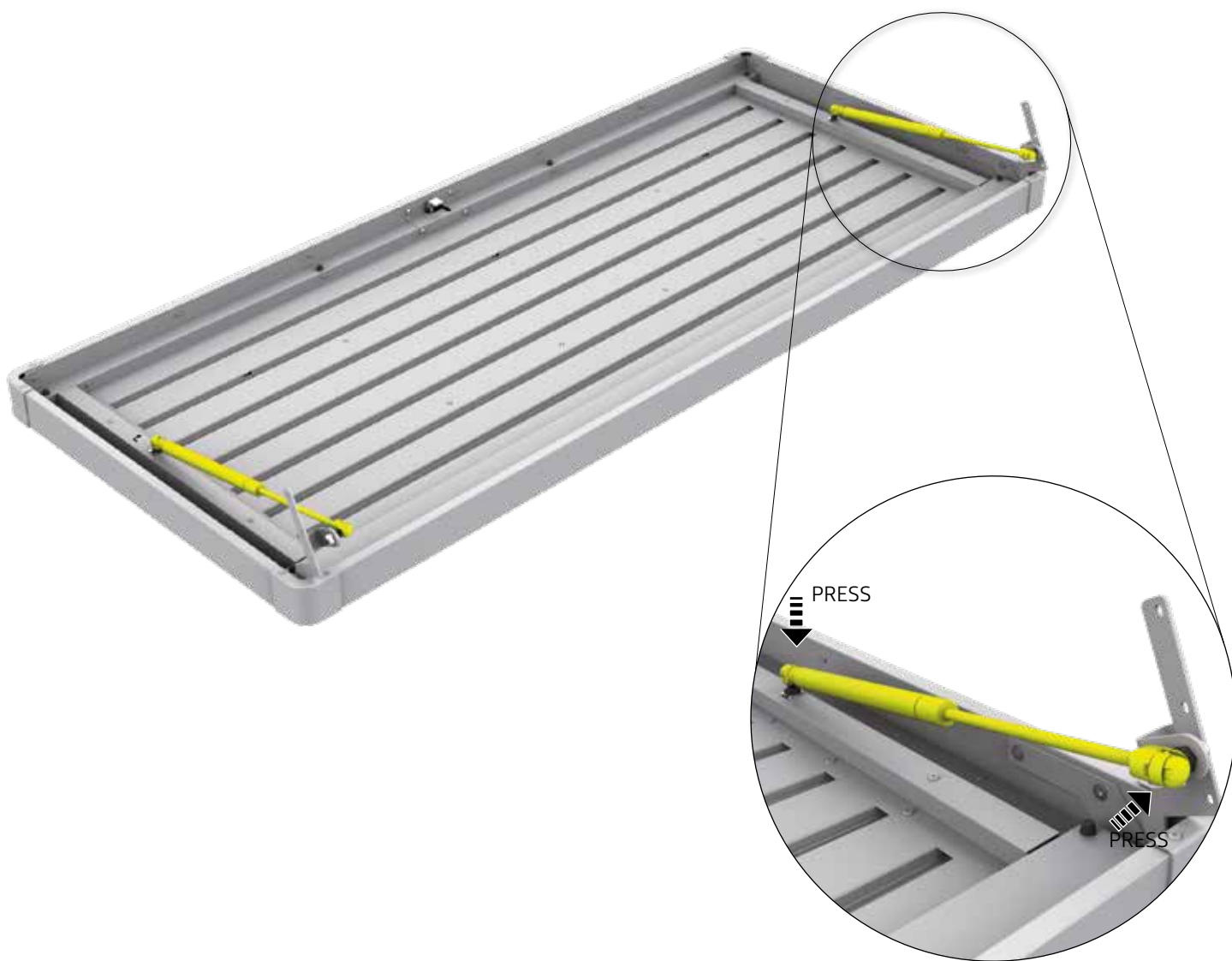
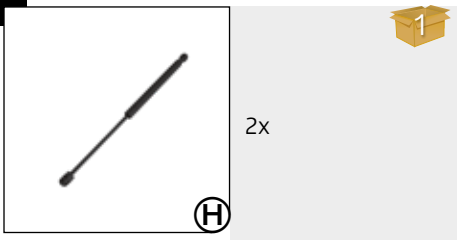

18.

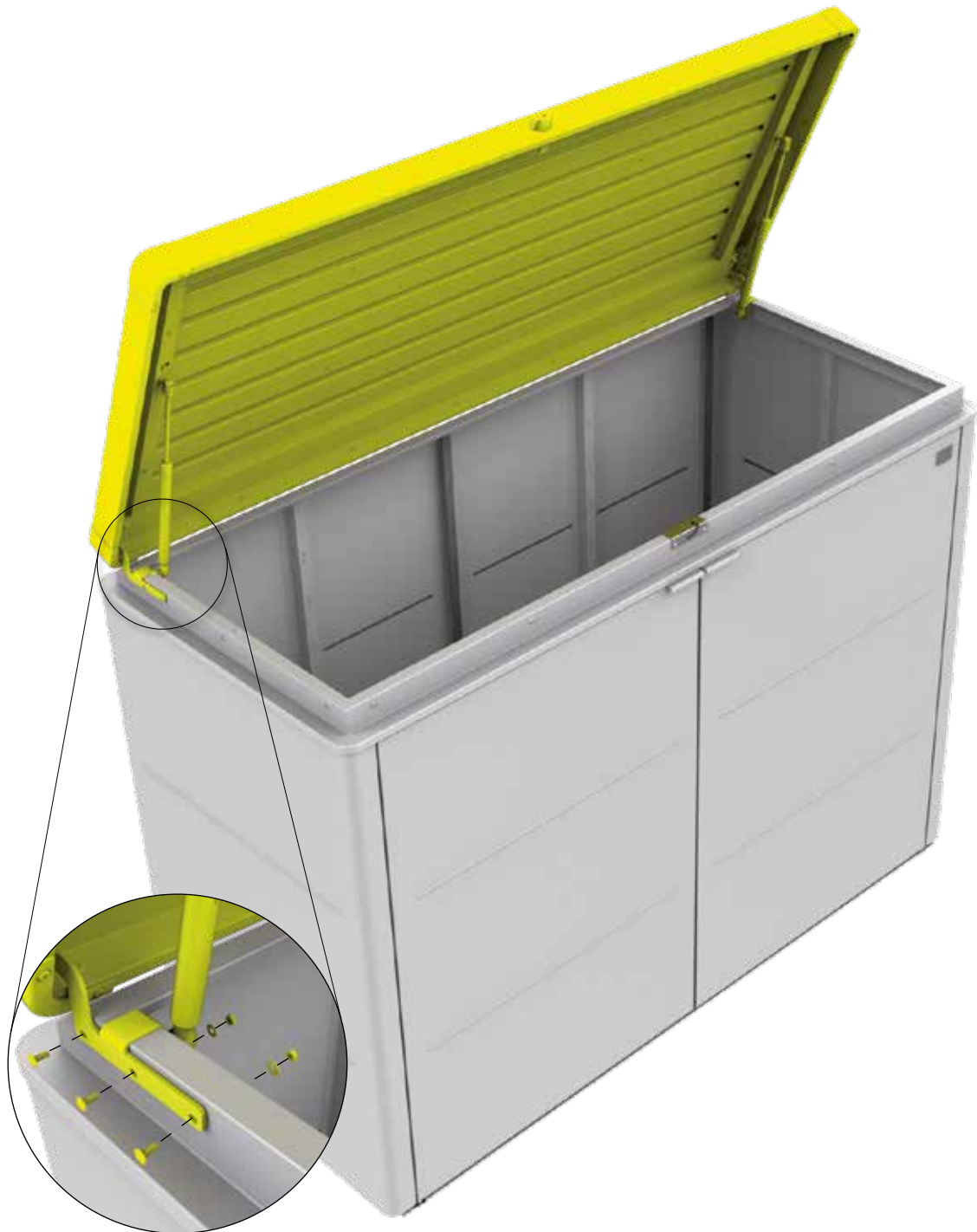
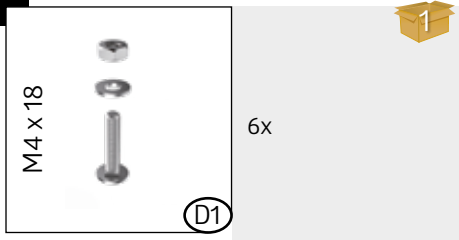

19.

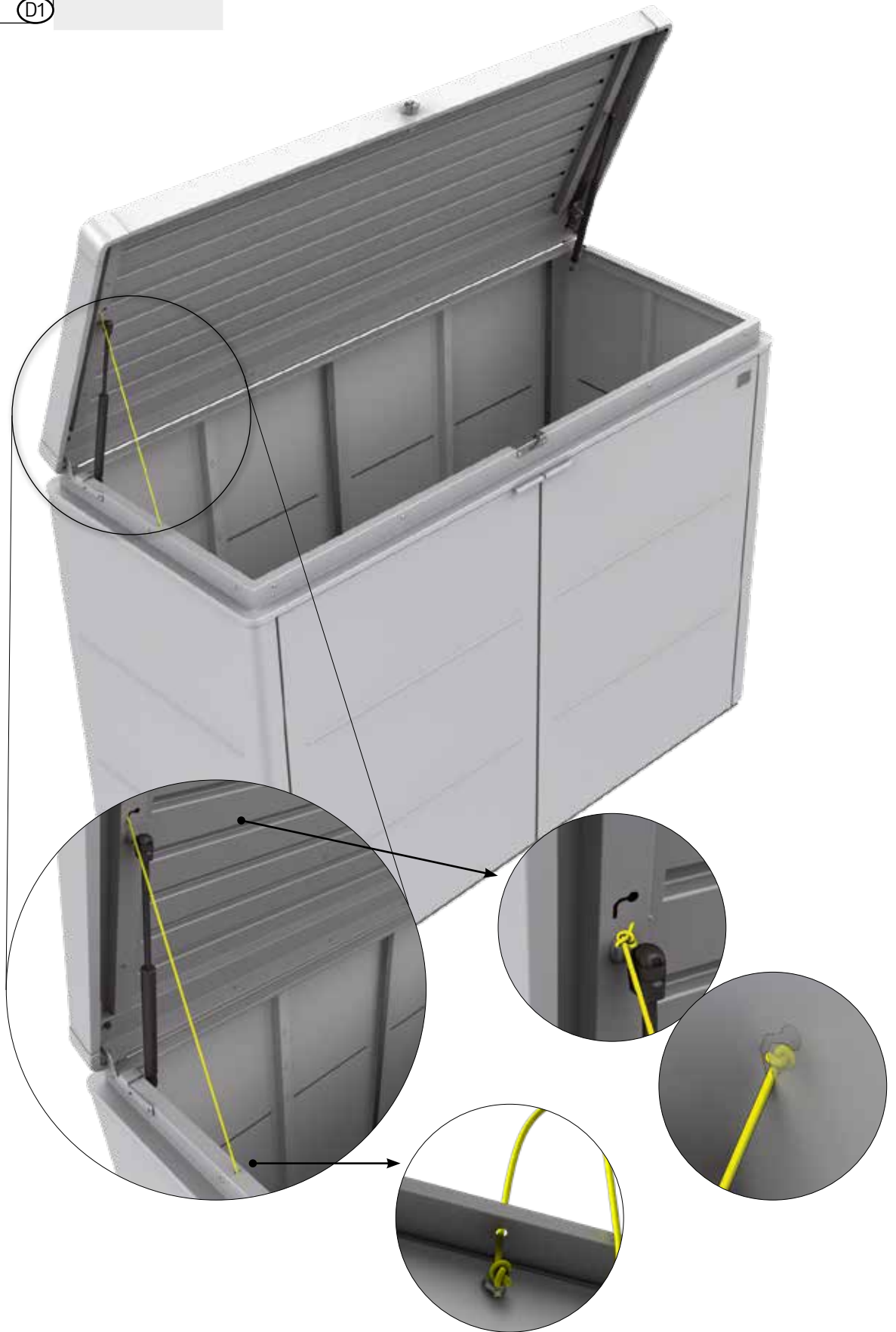
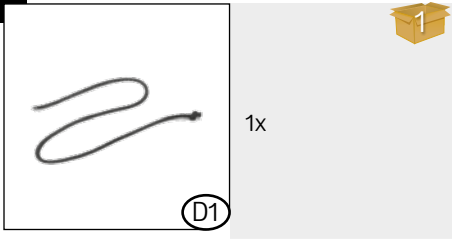



# 20.

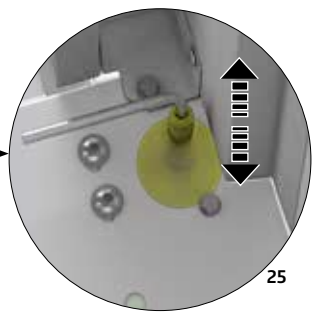
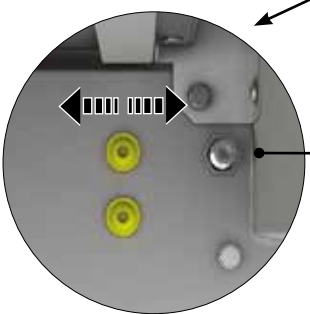
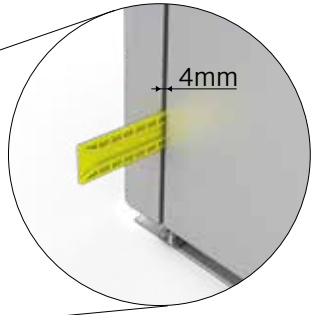
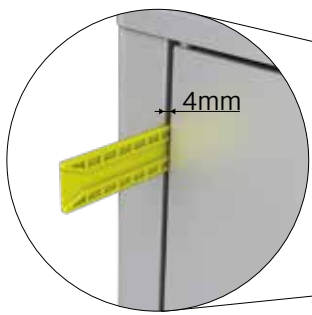
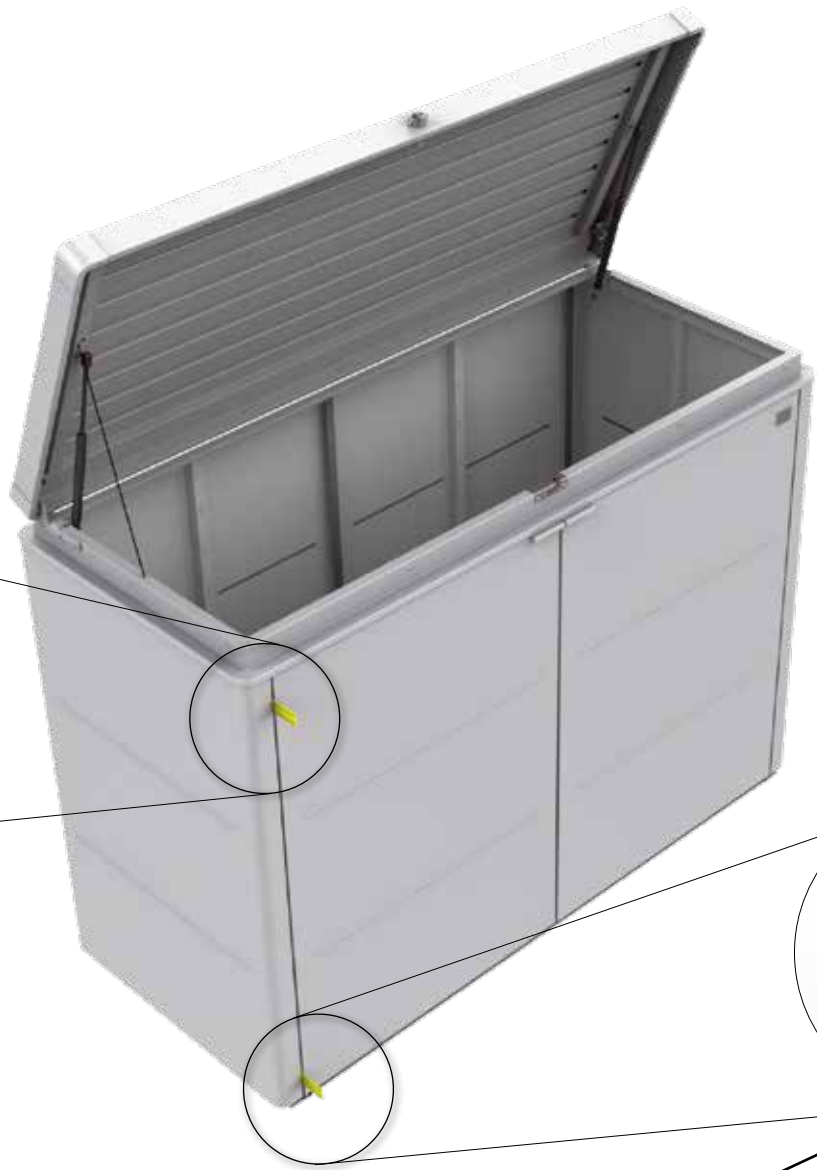
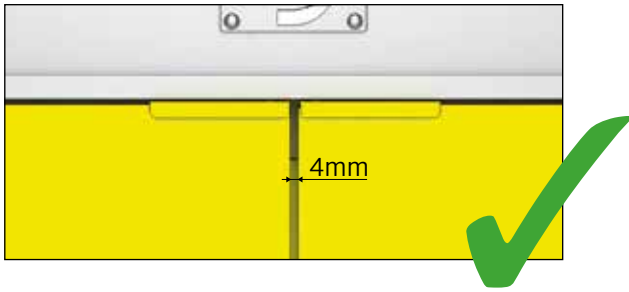
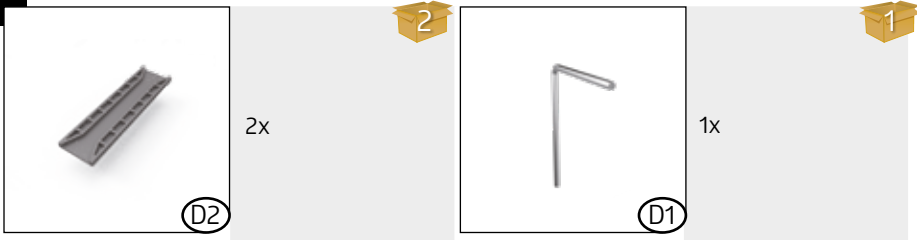

# 21.

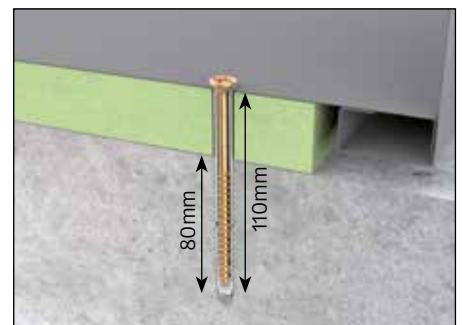
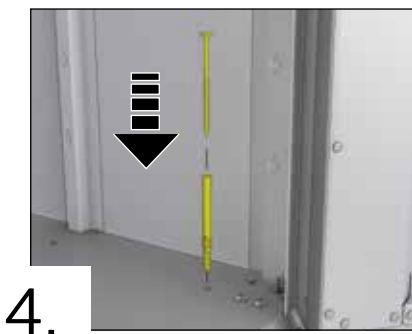
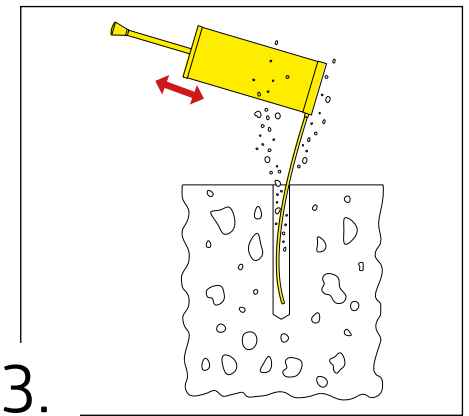
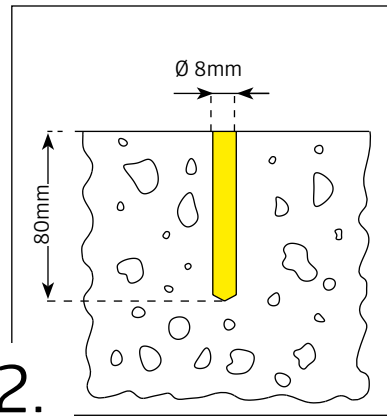
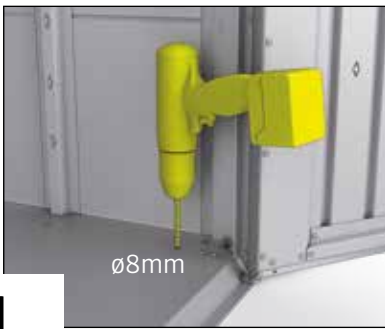
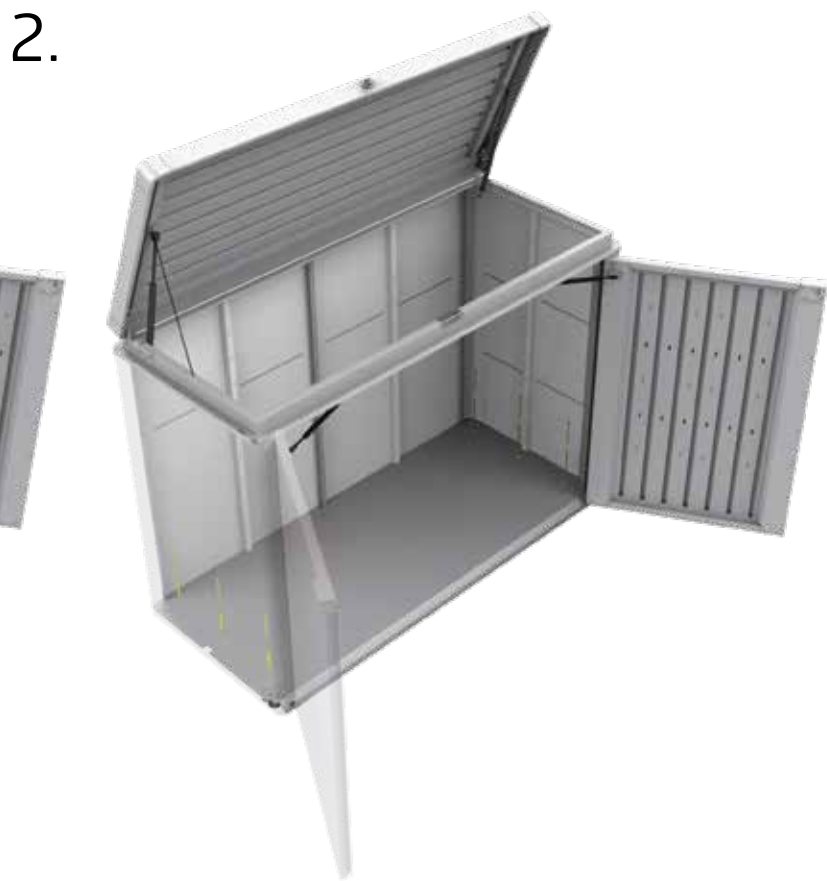

22.

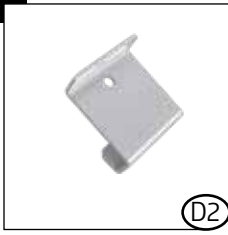

3x

2



3x

2

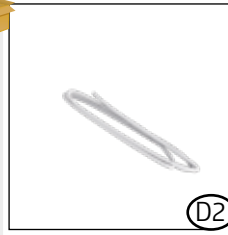

3x

2



23.





## Werkzeughalter

Tool holders - Supports de petits outils - Werktuighouders - Portautensili - Soportes para herramientas - Værktøjsholder

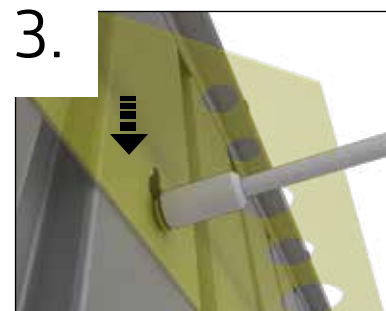
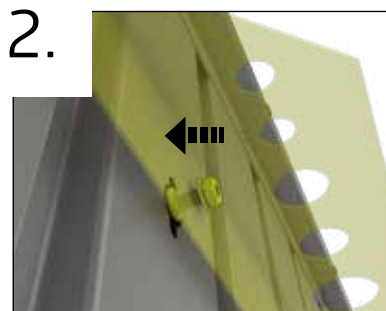
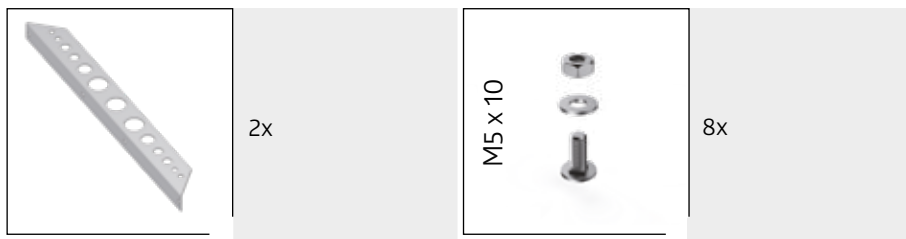



### Zwischenboden Opt. 1

Intermediate floors - Sol intermédiaire - tussenbodem - Ripiano intermedio - Balda intermedia - Mellemhylde

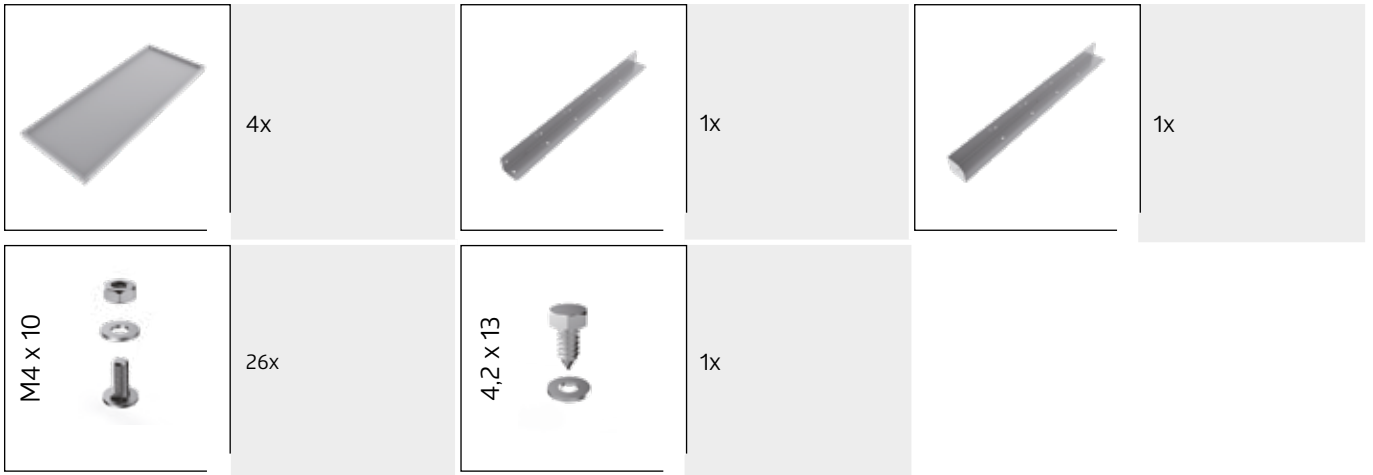

1.

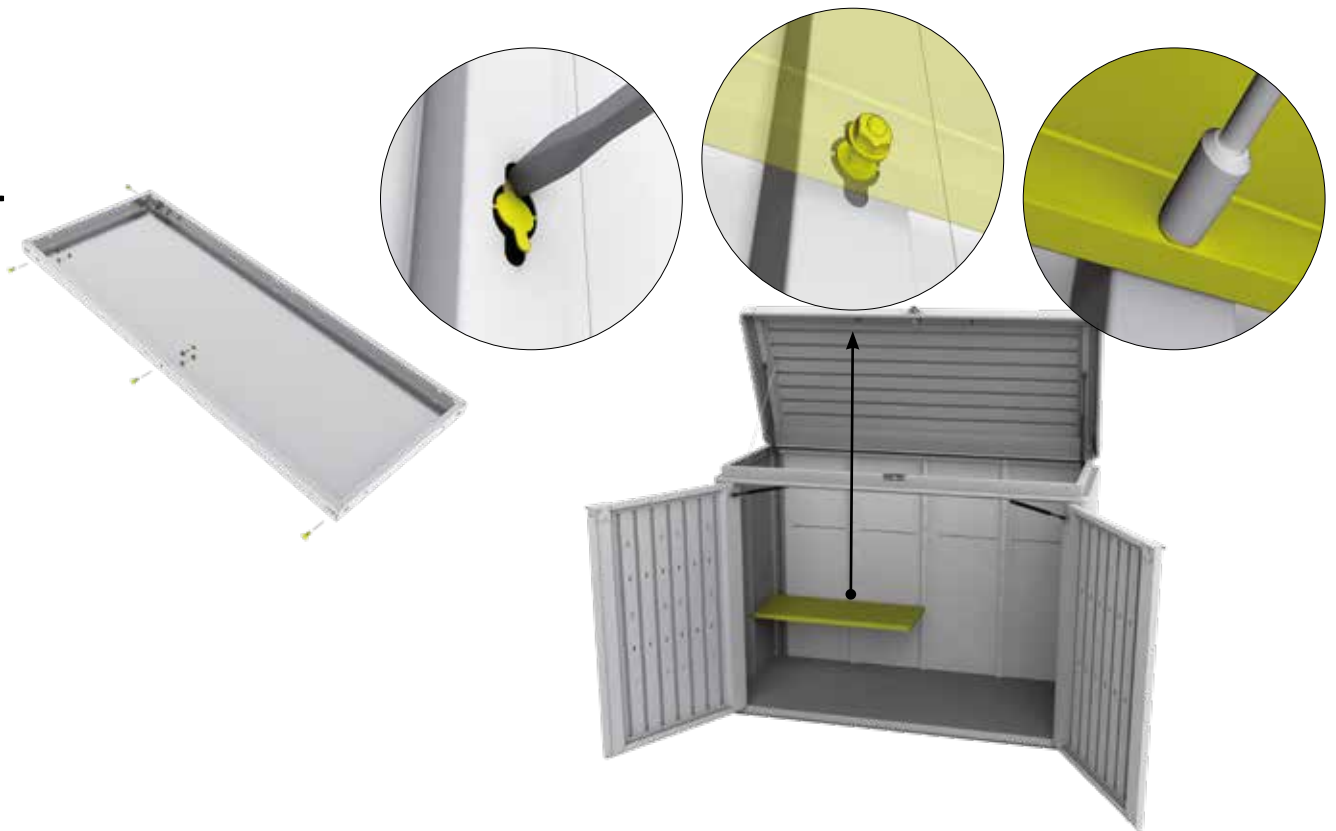

2.



3.



4.



5.

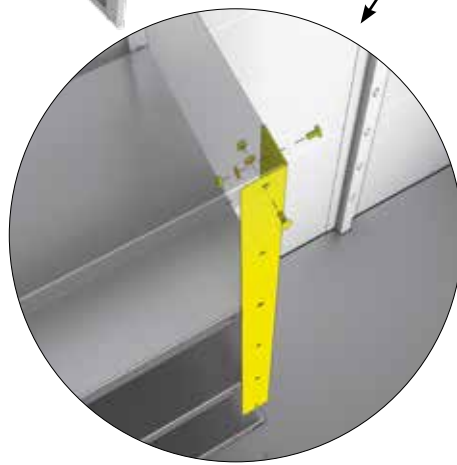
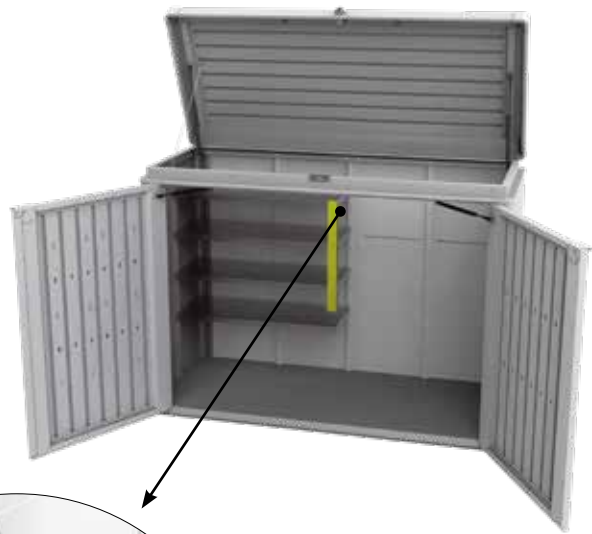

6.

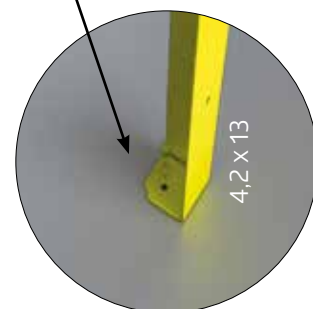
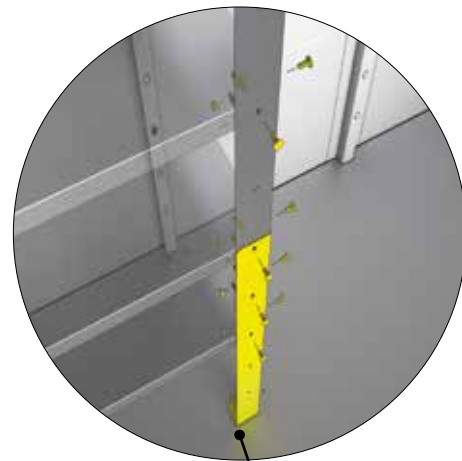



## Zwischenboden Opt. 2

Intermediate floors - Sol intermédiaire - tussenbodem - Ripiano intermedio - Balda intermedia - Mellemhylde

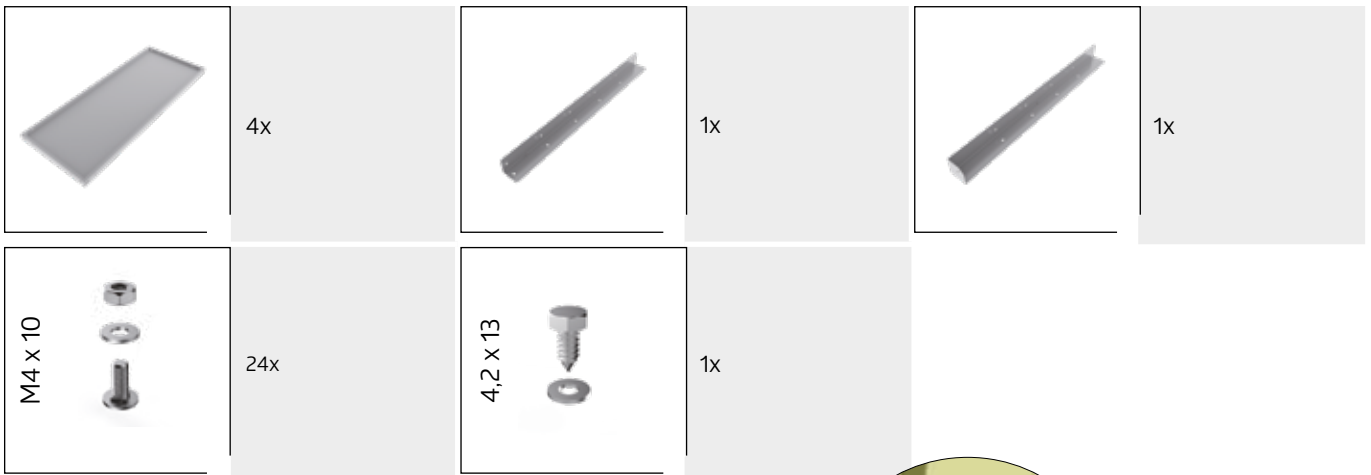

1.



2.

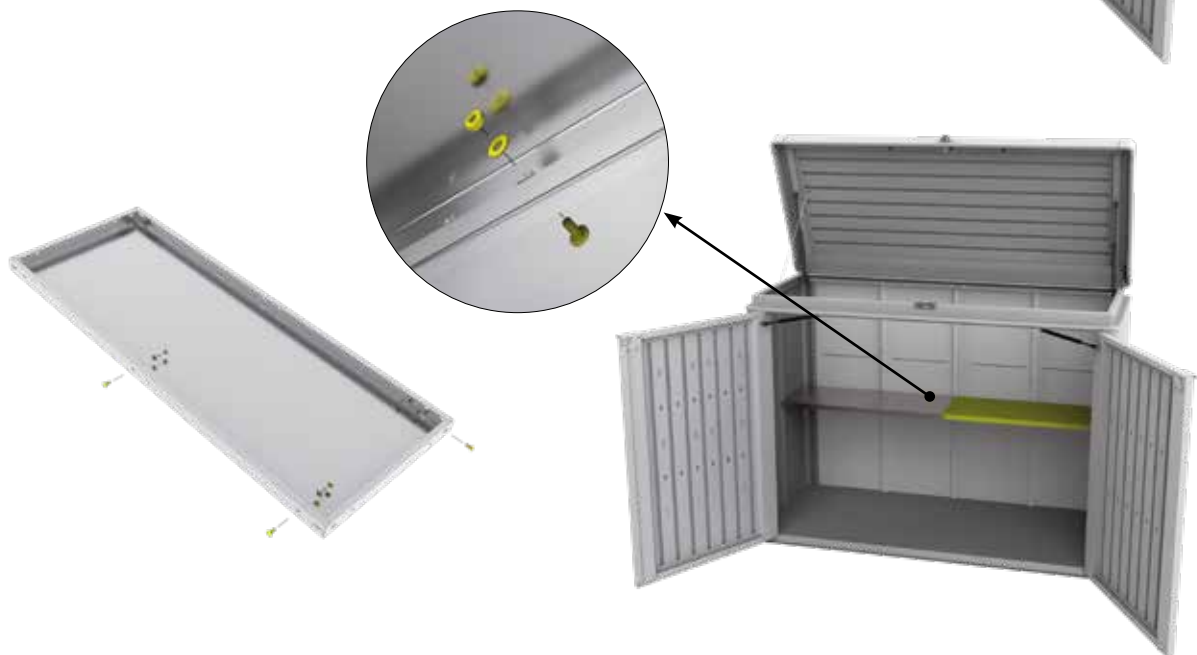



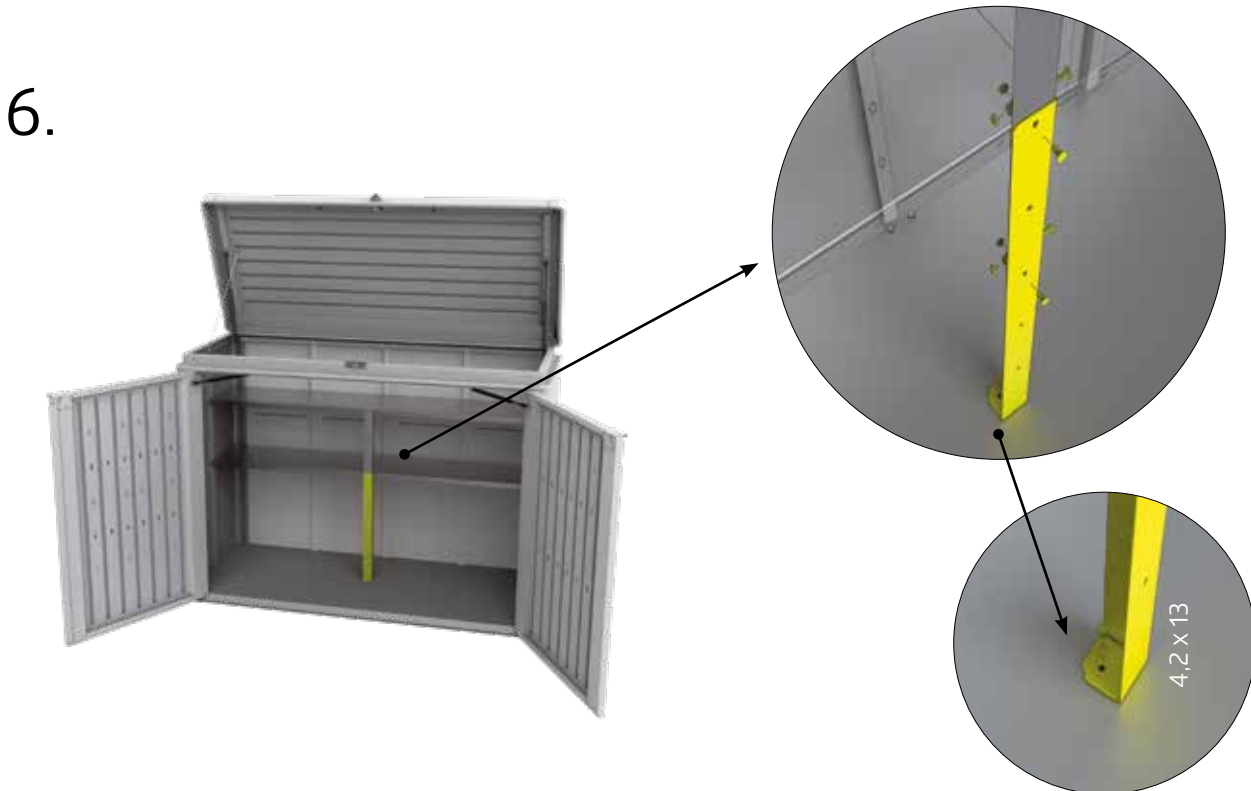
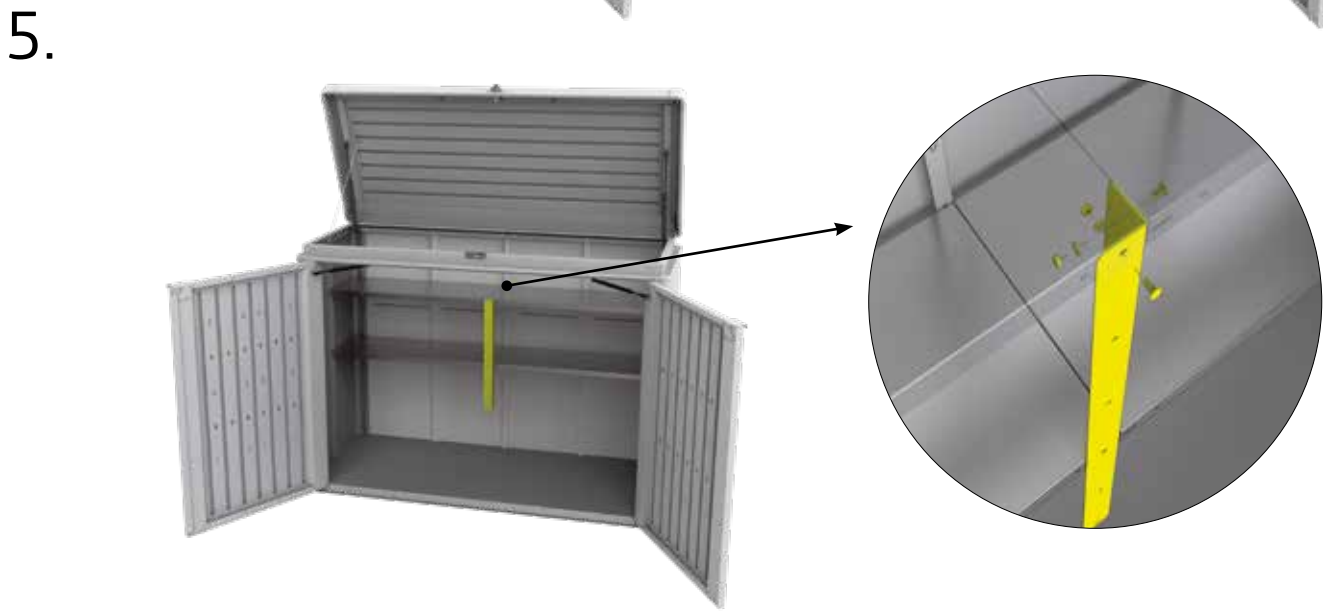
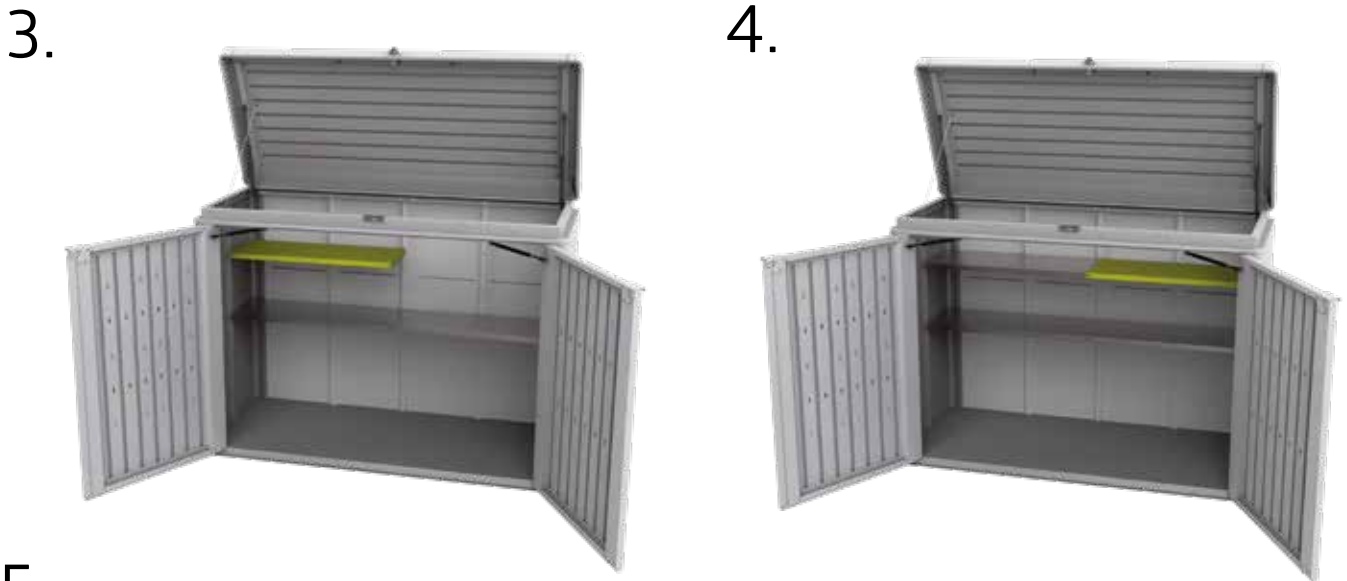





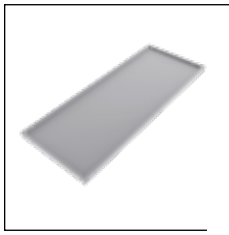

### Zwischenboden Opt. 3

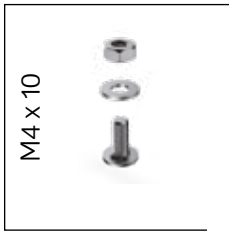
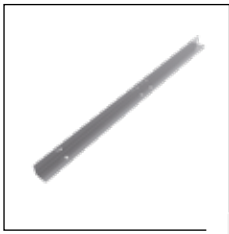
Intermediate floors - Sol intermédiaire - tussenbodem - Ripiano intermedio - Balda intermedia - Mellemhylde

	1x		1x		1x
M4 x 10 	28x		1x	4,2 x 13 	1x

1.



2.

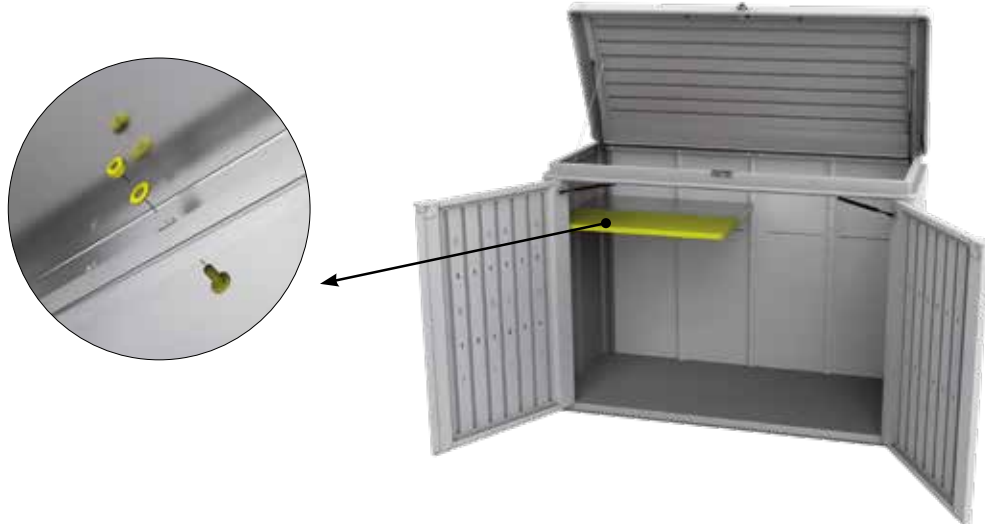

3.

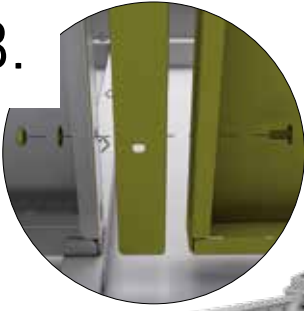

4.



5.





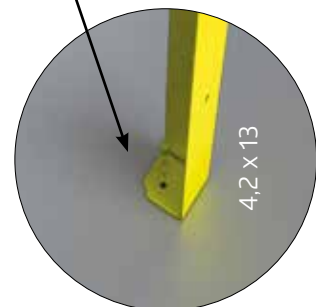
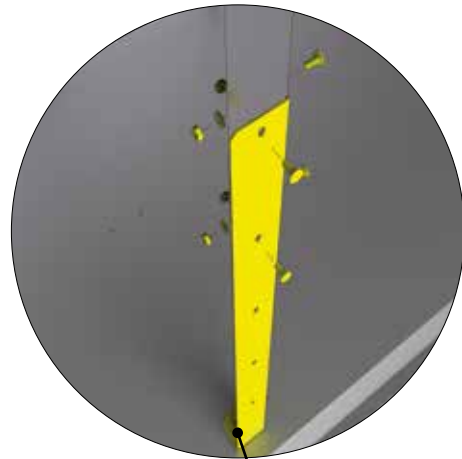



6.



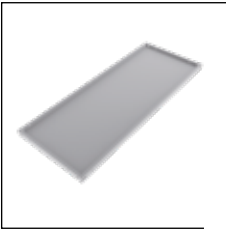

### Zwischenboden Opt. 4

Intermediate floors - Sol intermédiaire - tussenbodem - Ripiano intermedio - Balda intermedia - Mellemhylde

	4x		1x		1x
	30x		2x		1x

1.

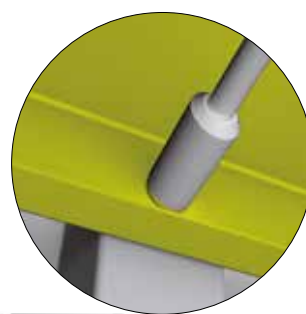

2.

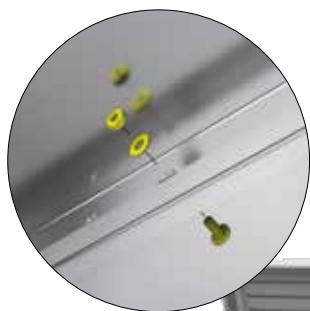

3.



4.



5.

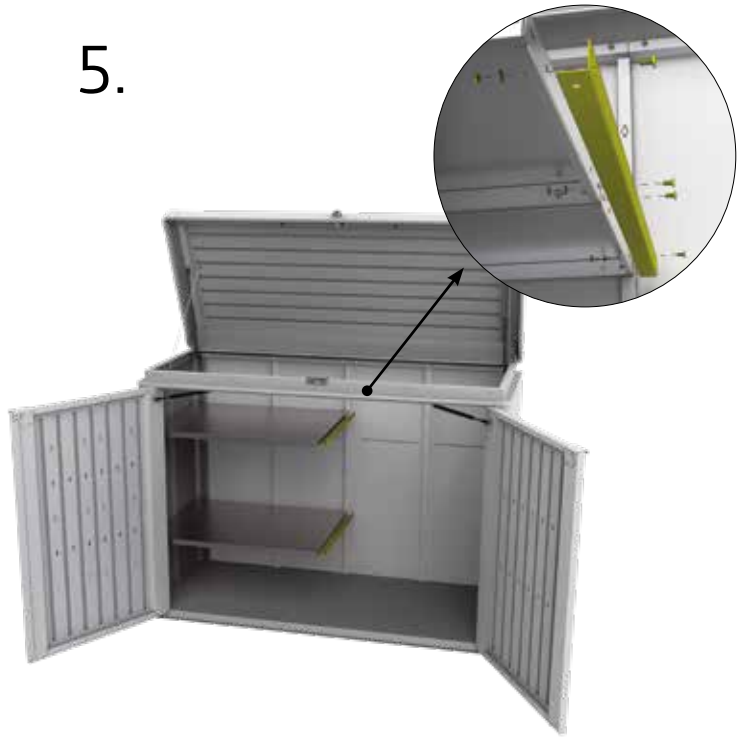

6.

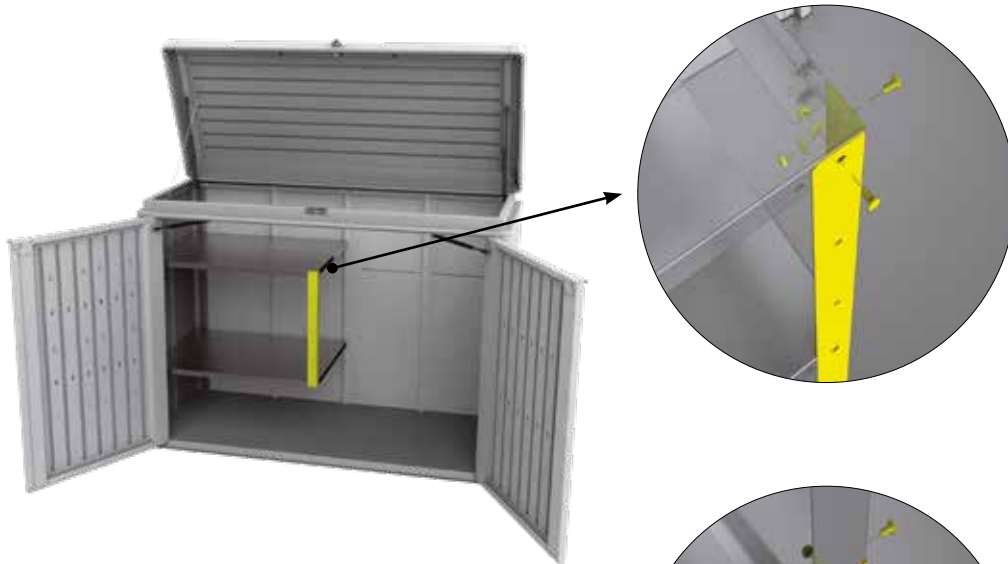

7.

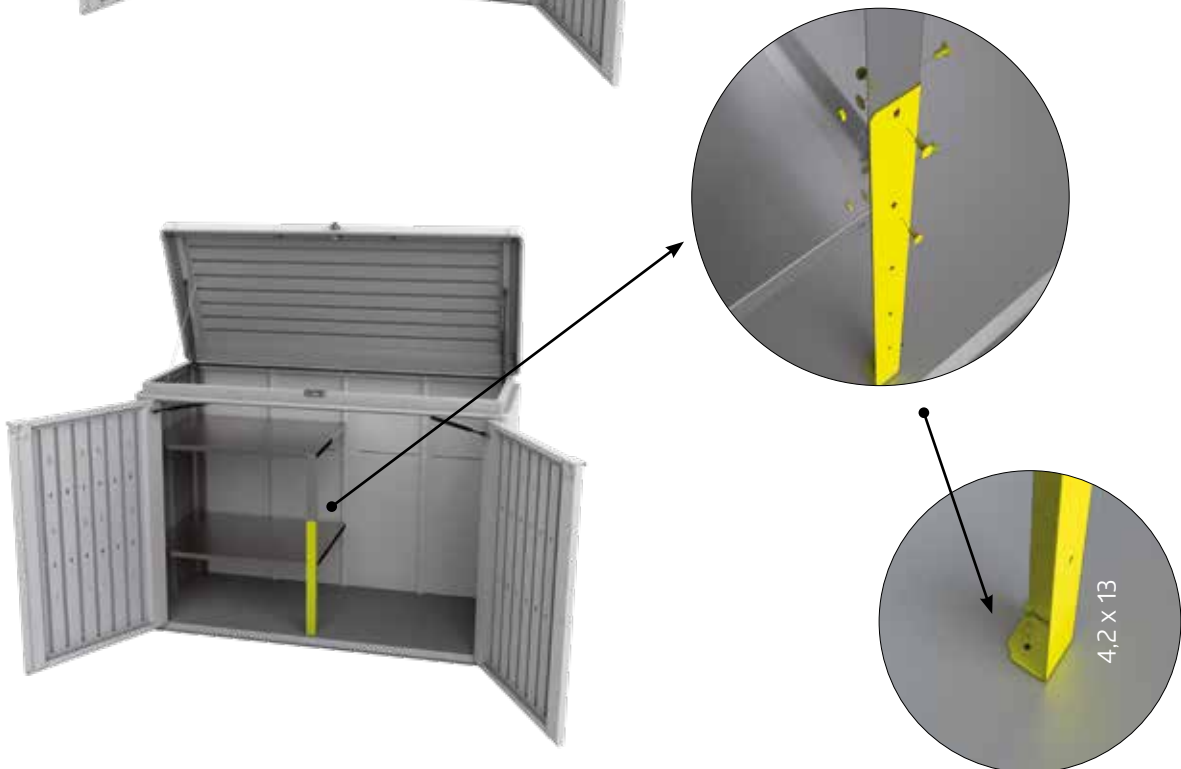







**GERÄTEHÄUSER** – Setzen Sie auf Qualität & Langlebigkeit  
**GARDEN SHEDS** – rely on quality & longevity



**GARTENBOXEN** – Outdoorboxen für Garten, Terrasse & Co.  
**OUTDOOR BOXES** – outdoor boxes for garden, patio & more



**FAHRRAD-GARAGEN** – Fahrräder, Roller & Co sicher verstaut  
**BICYCLE STORAGE** – for safe storage of bicycles, scooters & more



**MÜLLTONNEN-BOXEN** – Stylish, praktisch & wartungsfrei  
**DUSTBIN STORAGE** – stylish, practical & maintenance free



**GARTEN-HELFER** – Gartendesign in Bestform  
**GARDENING HELPERS** – garden design at its best

**Kontrollnummer:**

Control-number / Contrôle-Qualité / Controlnummer:

**Bei Reklamationen bitte anführen:**

**Kontrollnummer und Artikelnummer des reklamierten Teils.**

GB: In case of complaint please indicate the control-number and the number of the item, which is subject of complaint.

F: Pour toutes réclamations: prière de joindre le numéro de contrôle et le numéro d'article de la pièce litigieuse.

NL: Bij reclamaties svp doorgeven: controlnummer en artikelnummer van het desbetreffende onderdeel.

follow us:

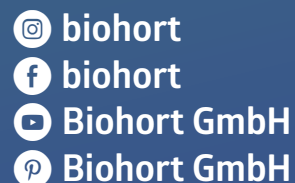

**Biohort GmbH**  
 Pürnstein 43, 4120 Neufelden, Österreich  
 Tel: +43-7282-7788-0  
 E-Mail: office@biohort.at, www.biohort.com