

# AUFBAUANLEITUNG WOODSTOCK®



- ⓐ Assembly manual for „WoodStock®“
- ⓑ Notice de montage „WoodStock®“
- Ⓒ Opbouwbeschrijving „WoodStock®“
- Ⓓ Instrucciones de montaje de „WoodStock®“
- Ⓔ Istruzioni di montaggio „WoodStock®“
- Ⓕ Monteringsvejledning for „WoodStock®“

For further languages please go to: [www.biohort.com/downloads](http://www.biohort.com/downloads)



# WICHTIGE PUNKTE FÜR DEN AUFBAU!



**VORLIEGENDE AUFBAUANLEITUNG ZEIGT DEN ZUSAMMENBAU VOM WOODSTOCK® „230“, SIE GILT SINNGEMÄSS AUCH FÜR DIE GRÖSSE „150“.**

- GB** Important details regarding assembly! This assembly manual shows the erection of the WoodStock® size "230"; it is also valid for size "150".
- FR** Points importants lors du montage! Cette notice de montage décrit l'assemblage du produit WoodStock® taille « 230 »; celle-ci est aussi valable pour la taille «150».
- NL** Deze montage instructies hebben betrekking op de opbouw van de WoodStock® , grootte 230. De instructies zijn ook van toepassing op de grootte 150.
- ES** Notas importantes para el montaje: Estas instrucciones muestran el montaje del arcón WoodStock® en tamaño 230. También son válidas para el tamaño 150.
- IT** Indicazioni importanti per il montaggio! Le seguenti istruzioni di montaggio fanno riferimento all'assemblaggio di WoodStock® misura "230"; per analogia sono valide anche per la misura "150".
- DK** Vigtige punkter ved samling! Samlemanualen viser opsætningen af modellen WoodStock® str. "230"; gælder også for størrelse "150".

## VERWENDEN SIE BEI DER MONTAGE ARBEITSHANDSCHUHE! UM KRATZER ZU VERMEIDEN, VERWENDEN SIE BITTE GEEIGNETE UNTERLAGEN!

- GB** Wear working gloves! Please use a suitable underlay to avoid scratches!
- FR** Portez des gants de travail! Pour éviter les rayures, utilisez les supports appropriés!
- NL** Handschoenen gebruiken! Om krassen te voorkomen raden wij u aan er iets onder te leggen!
- ES** Utilice unos guantes de trabajo. Por favor, coloque en el suelo una base protectora adecuada para evitar posibles arañazos.
- IT** Utilizzare guanti da lavoro. Utilizzare una base adatta per evitare graffi!
- DK** Brug arbejdshandsker! Benyt venligst et passende underlag for at undgå skrammer!



## ACHTEN SIE AUF EINE STURMSICHERE BODENVERANKERUNG UND VERRIEGELN SIE TÜREN! NICHT BEI WIND AUFBAUEN!

- GB** Please make sure the product is anchored in a storm-proof manner and lock the doors/lid! Do not assembly in windy condition!
- FR** Veillez à ce que le sol soit ancré de manière à résister aux tempêtes et verrouillez les portes/couvercles ! Ne pas procéder au montage dans des conditions venteuses !
- NL** Zorg voor een stormbestendige bodem verankering en vergrendel de deuren/deksel! Niet opbouwen in winderige omstandigheden!
- ES** Asegúrese de que el suelo cuente con un anclaje a prueba de tormentas y cierre las puertas/tapas. ¡No se instalen en condiciones de viento!
- IT** Assicuratevi che il pavimento sia ancorato a prova di tempesta e chiudete a chiave le porte/coperchio! Non montare in condizioni di vento!
- DK** Vær opmærksom på at produktet forankres stormsikkert samt at dør/låg er aflåst! Bør ikke monteres ved kraftig vind!



## WASSERWAAGEN - SYMBOL:

**Betreffendes Einbauteil mit der Wasserwaage ausrichten.**

- GB** Symbol of spirit level: Align the respective parts by using the spirit level..
- FR** Symbole niveau à bulle: Lorsque ce symbole apparaît, vous devez ajuster l'élément à l'aide d'un niveau à bulle.
- NL** Waterpas - symbol: Bij montageschappen waar dit symbool bijstaat is het noodzakelijk het betreffende onderdeel waterpas in te bouwen.
- ES** Símbolo del nivelador: Indica que se debe ajustar y centrar la pieza con la ayuda de un nivelador.
- IT** Simbolo di livella a bolla d'aria: Allineare il componente in questione con l'ausilio di una livella a bolla d'aria.
- DK** Symbol for vaterpas: Juster de respektive dele ved hjælp af vaterpas.

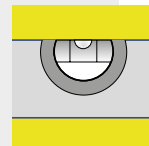

## SCHRAUBVERBINDUNGEN GRUNDSÄTZLICH ERST AM ENDE DER MONTAGE FESTZIEHEN!

- GB** Nuts not to be tightened before the end of assembly!
- FR** Ne serrer les écrous à fond qu'à la fin du montage!
- NL** Schroeven pas aan het einde van de montage vastdraaien!
- ES** En principio, no apriete fijamente las tuercas hasta que no haya terminado de montar la caseta.
- IT** I dadi devono essere serrati a fondo soltanto alla fine del montaggio!
- DK** Møtrikkerne må ikke strammes før slutningen af opsætningen!

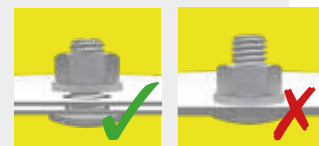

## ACHTUNG: IM SOMMER KÖNNEN IM INNENRAUM SEHR HOHE TEMPERATUREN ENTSTEHEN!

- (GB)** Attention: during the summer high temperature might arise in the interior.
- (FR)** Attention: En été la température à l'intérieur de l'abri peut être élevée!
- (NL)** Let op: in de zomer kunnen in de berging zeer hoge temperaturen bereikt worden.
- (ES)** Tenga en cuenta que en el verano las temperaturas en el interior pueden ser altas.
- (IT)** I dadi devono essere serrati a fondo soltanto alla fine del montaggio!
- (DK)** Attention: Si prega di prendere nota che in estate si possono essere temperature molto elevate all'interno.

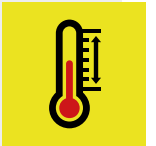

## PFLEGE UND WARTUNG

**Keine aggressiven Chemikalien wie z.B. Chlor oder Streusalz lagern! Sonnenmilch und andere Cremes mit Wasser und Seife entfernen. Keine scheuernden Reinigungsmittel verwenden! Laub vom Dach regelmäßig entfernen! Dachgully kontrollieren! Tiefe Kratzer sofort mit beiliegendem Lack ausbessern! Ölen Sie das Schloss jährlich! Schraubverbindungen regelmäßig kontrollieren!**

- (GB)** Care and maintenance: Do not store aggressive substances i.e. chlorine or road salt! Remove suntan lotion or any other creams with soap and water! Do not use abrasive cleaning agents! Keep the roof free of leaves! Check roof gully! ! Touch-up scratches immediately with the paint provided. Lubricate the lock once a year! Check screw connections regularly!
- (FR)** Entretien et maintenance: Ne pas stocker de produits chimiques (chlore, sel, etc...)! Nettoyez uniquement avec de l'eau les crèmes solaires et autres crèmes (pas de nettoyant chimique). Ne pas utiliser de produits nettoyant abrasifs! Débarrassez vous régulièrement des feuilles mortes sur le toit! Vérifiez la gouttière du toit! Corrigez immédiatement les rayures avec la laque jointe! Graissez la serrure et les charnières chaque année! Vérifiez régulièrement les raccords à vis!
- (NL)** Onderhoud: Geen chemicaliën in de berging opslaan! Zonnebrandolie/melk en andere cremes met water en glansmiddel verwijderen. Gebruik geen schuurmiddelen! Regelmatig bladeren van dak verwijderen! Controleer de dakgoot! · Krassen direct met de meegeleverde lak behandelen. Slot jaarlijks oliën. Controleer regelmatig de schroefverbindingen!
- (ES)** Cuidado y mantenimiento: No almacene productos químicos agresivos dentro de la caseta como por ejemplo cloro y sal antiescarcha. Evite dejar huellas o restos de cremas solares sobre la chapa. Limpie la caseta siempre con agua y jabón. No utilice ningún producto para fregar. En general, evite siempre cualquier producto químico para limpiar la caseta. Mantenga el tejado libre de hojas secas. Compruebe el desagüe del tejado. Repare los arañazos lo antes posible con el barniz que se incluye. Aplique aceite en la cerradura y las bisagras una vez al año. ¡Compruebe las conexiones de los tornillos regularmente!
- (IT)** Manutenzione: Non lasciare prodotti chimici aggressivi (come ad esempio cloro o sale per strade) all'interno della casetta! Rimuovere crema solare e altre creme con acqua e brillante! Non utilizzare detergenti contenenti sostanze aggressive! Mantenere il tetto libero da foglie! Controllare la grondaia! Ritoccare immediatamente eventuali graffi con la vernice fornita nella confezione! Lubrificare la serratura e le cerniere a cadenza annuale! Controllare regolarmente i collegamenti a vite!
- (DK)** Pleje og vedligeholdelse: Opbevar ikke aggressive stoffer dvs. Klor eller vejsalt! Fjern solcreme eller andre typer af creme med vand og rensningsmiddel! Brug ikke aggressive rengøringsmidler! Hold taget fri for blade! Kontroller tag afløb! ! Ved skrammer, brug straks malingen som er stillet til rådighed! Smør låsen årligt! Kontroller skruesamlinger jævnligt!

## MASSTABSGETREUE ABBILDUNGEN DER ZU VERWENDENDEN SCHRAUBEN: (M 1:1)

- (GB)** Scale drawing 1:1 of the screws in use
- (FR)** Reproduction selon l'échelle 1:1.
- (NL)** Afbeelding : schaal 1:1 (ware grootte)
- (ES)** Reproducción a escala 1:1 de los tornillos que se utilizan para el montaje.
- (IT)** Immagine in scala delle viti da utilizzare!
- (DK)** Skala tegning af skruer er 1:1

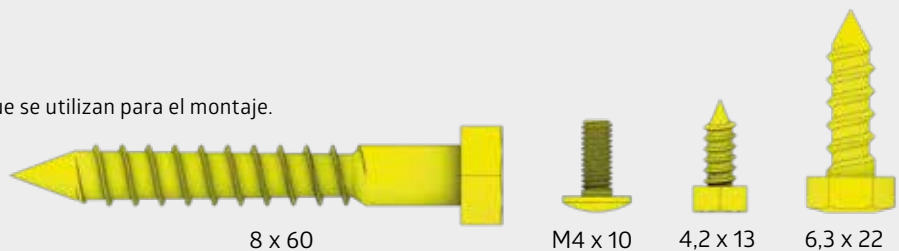

## HALTEN SIE WÄHREND DES ZUSAMMENBAUS ALLE MITGELIEFERTEN KLEINTEILE ODER VERPACKUNGSMATERIALIEN FERN VON KLEINKINDERN.

**Bauteile weisen scharfe Kanten auf oder stehen vor, achten Sie während der Montage und bei der täglichen Nutzung darauf.**

- (GB)** Keep all supplied small parts or packaging materials away from small children during assembly. Components have sharp edges or protrude, pay attention to them during assembly and during daily use.
- (FR)** Gardez toutes les petites pièces ou les matériaux d'emballage fournis hors de portée des enfants pendant le montage. Les pièces d'assemblage peuvent être tranchantes, faites-y attention lors de l'assemblage et de l'utilisation quotidienne.
- (NL)** Houd alle kleine onderdelen of verpakkingsmaterialen die worden mee geleverd uit de buurt van kleine kinderen tijdens de montage. Onderdelen hebben scherpe randen of steken uit, let op bij de montage en bij het dagelijks gebruik.
- (ES)** Mantenga todas las piezas pequeñas o materiales de embalaje suministrados lejos de los niños durante el montaje. Los componentes tienen bordes afilados o salientes, preste atención a ellos durante el montaje y durante el uso diario.
- (IT)** Tenere tutte le piccole parti o i materiali d'imballaggio forniti lontano dalla portata dei bambini durante il montaggio. I componenti hanno spigoli vivi o sporgenti, prestare attenzione ad essi durante il montaggio e durante l'uso quotidiano.
- (DK)** Hold alle leverede smådele og emballage utilgængeligt for børn under montagen. Komponenter har skarpe kanter eller stikker ud, vær opmærksom på dem under montering og under daglig brug.

## MASSE FÜR DAS FUNDAMENT

- Ⓜ Foundation dimensions
- Ⓜ Dimensions pour la fondation
- Ⓜ Maat voor het fundament
- Ⓜ Medidas de los cimientos
- Ⓜ Dimensioni del basamento
- Ⓜ Fundament dimensioner

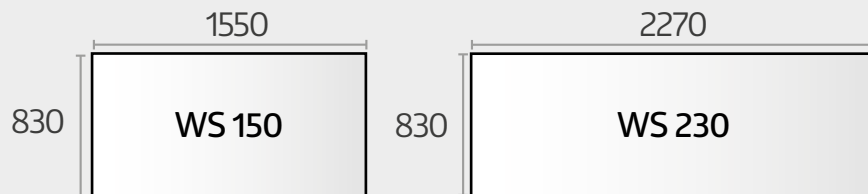

## FUNDAMENTLÖSUNGEN

- Ⓜ Foundation solutions
- Ⓜ Solutions de fondations
- Ⓜ Fundamentsoplossingen
- Ⓜ Soluciones de fundamentación
- Ⓜ Soluzioni per la fondazione
- Ⓜ Fundamentløsninger



[biohort.com/fundament](https://biohort.com/fundament)

## TEILEÜBERSICHT

parts list · liste des pièces · stuklijst · lista de piezas · lista de parti · deloversigt

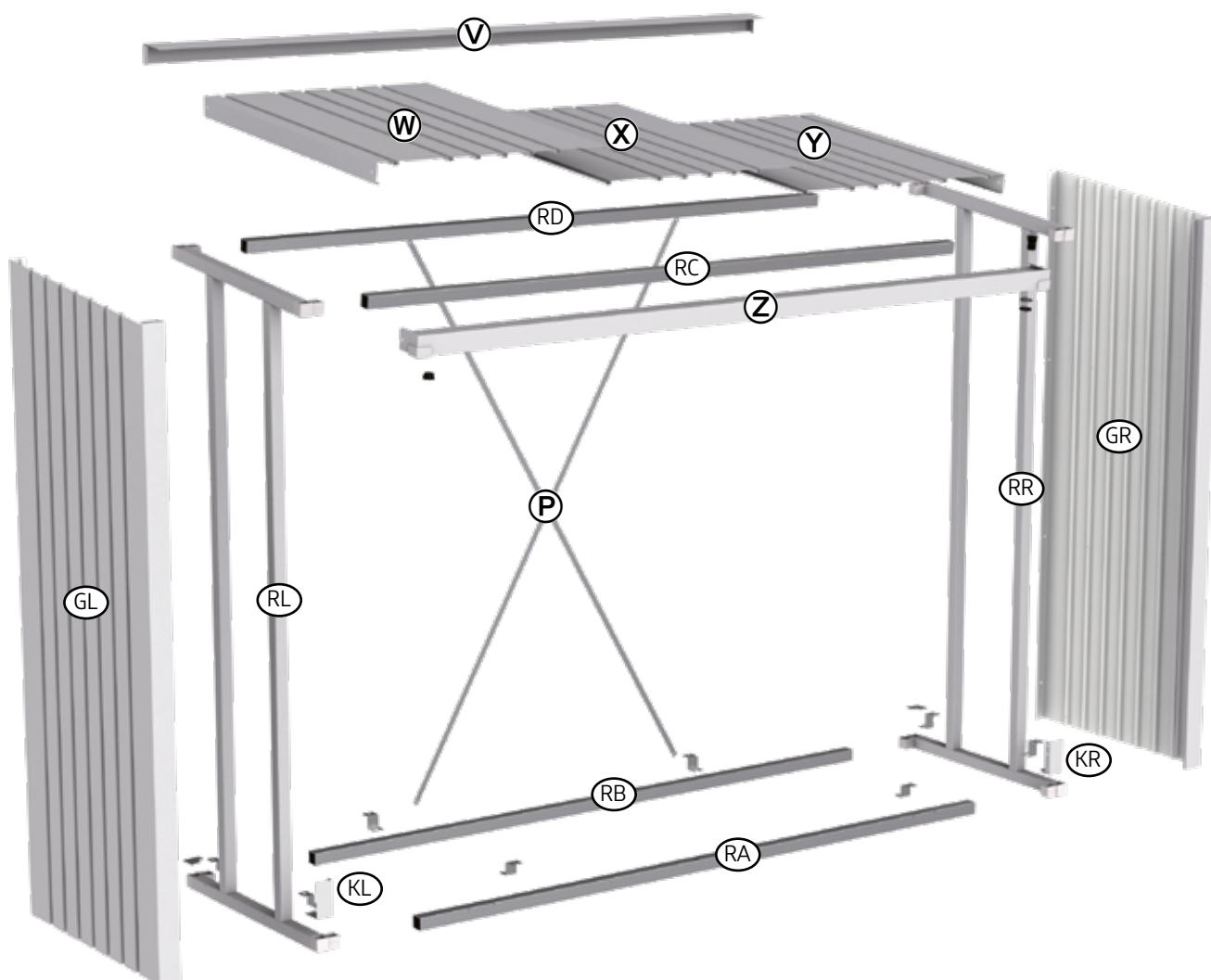



# TEILEÜBERSICHT

parts list · liste des pièces · stuklijst · lista de piezas · lista de parti · deloversigt

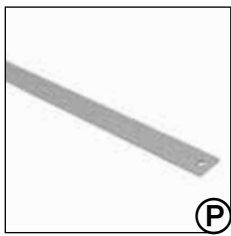
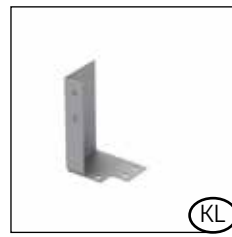
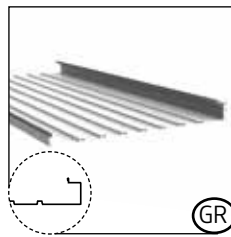
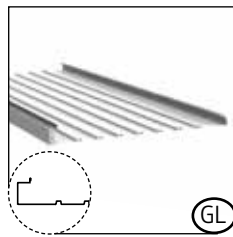
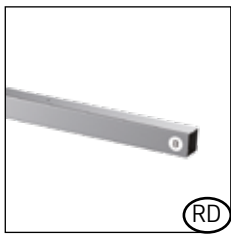
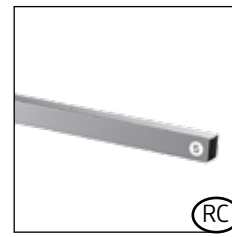
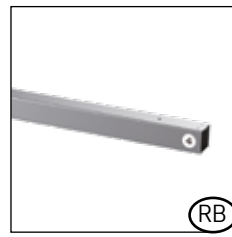
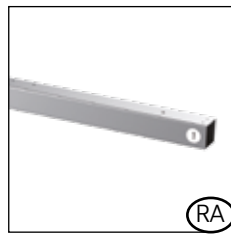

**Nur für Größe 230**  
 Only for size 230  
 Uniquement pour taille 230  
 Alleen voor maat 230  
 Sólo para los tamaños 230  
 Solo per misura 230  
 Kun for størrelse 230

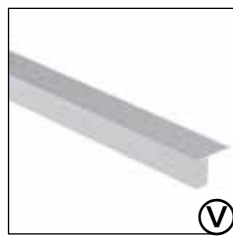
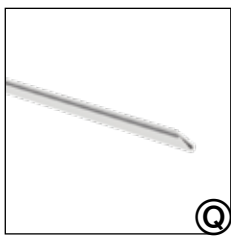

## KLEINTEILEPAKET

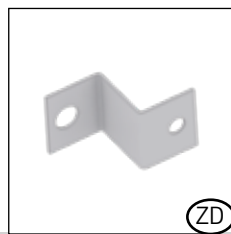
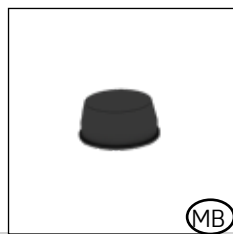

double door package | carton de double portes

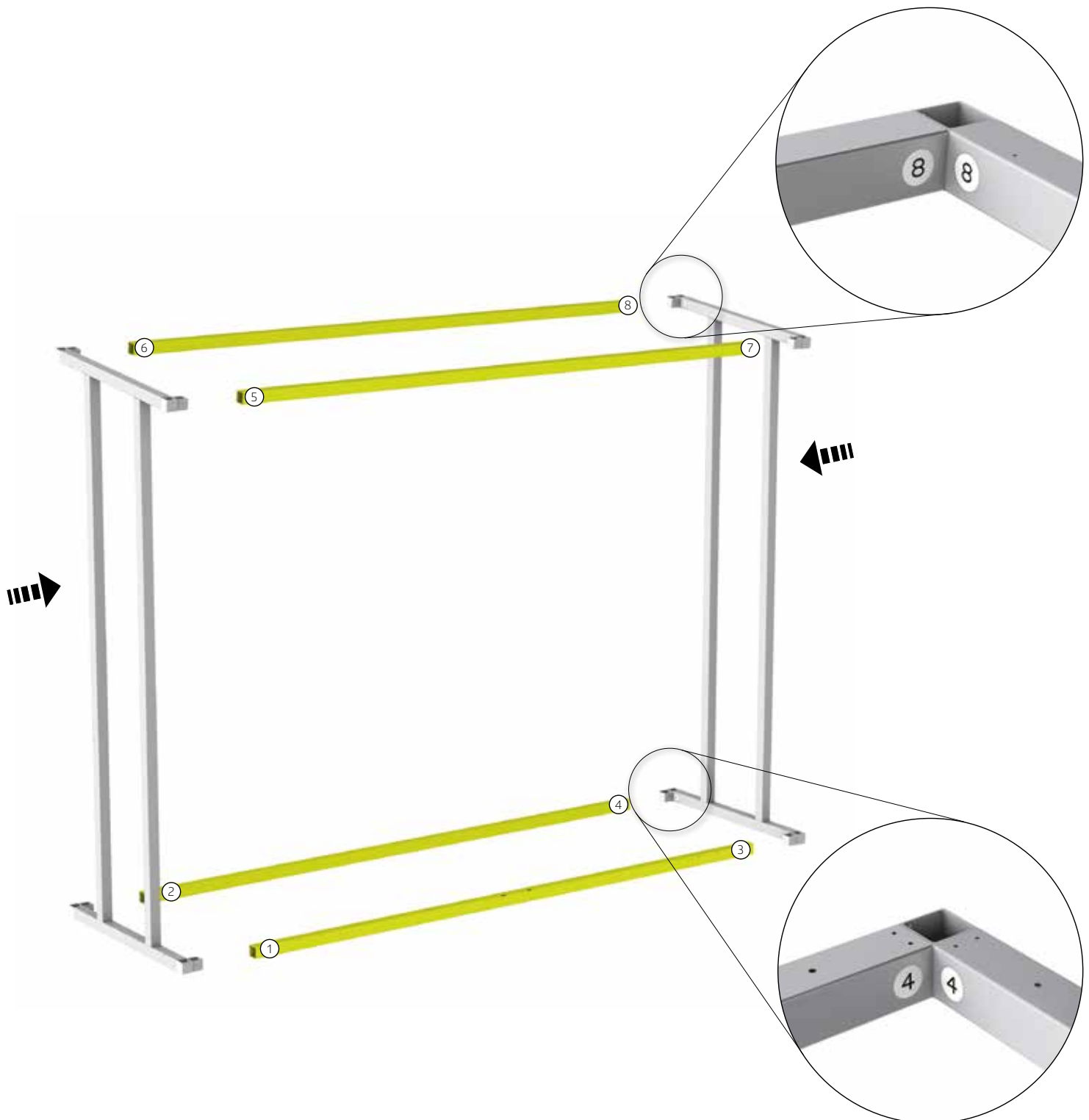
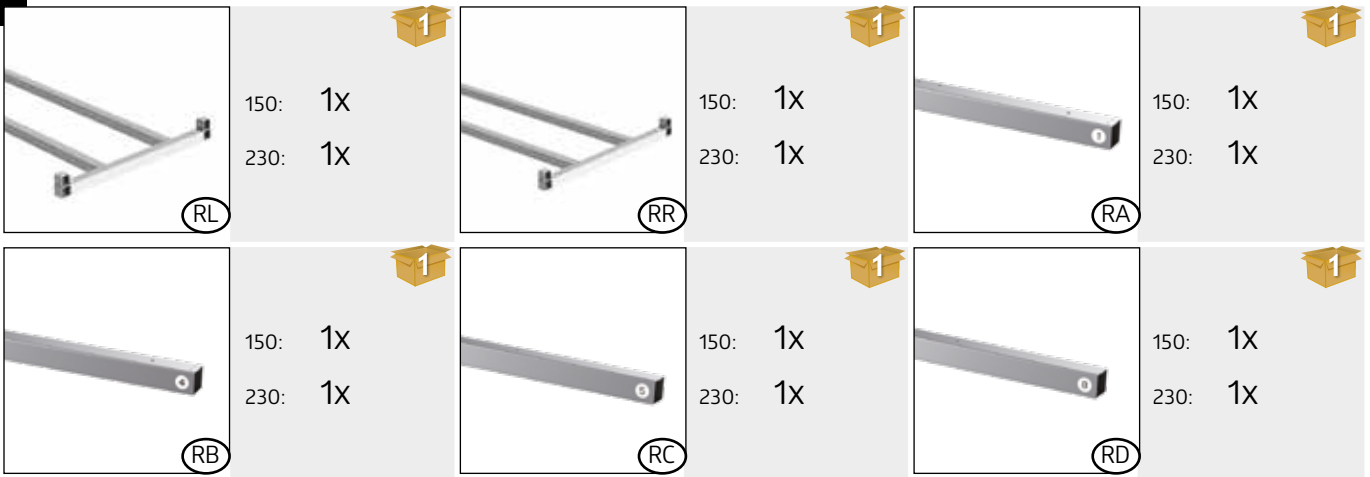

1.



# 2.

 (D1)	150: 2X	 4,2 x 13 (D1)	150: 8X
	230: 2X		230: 8X

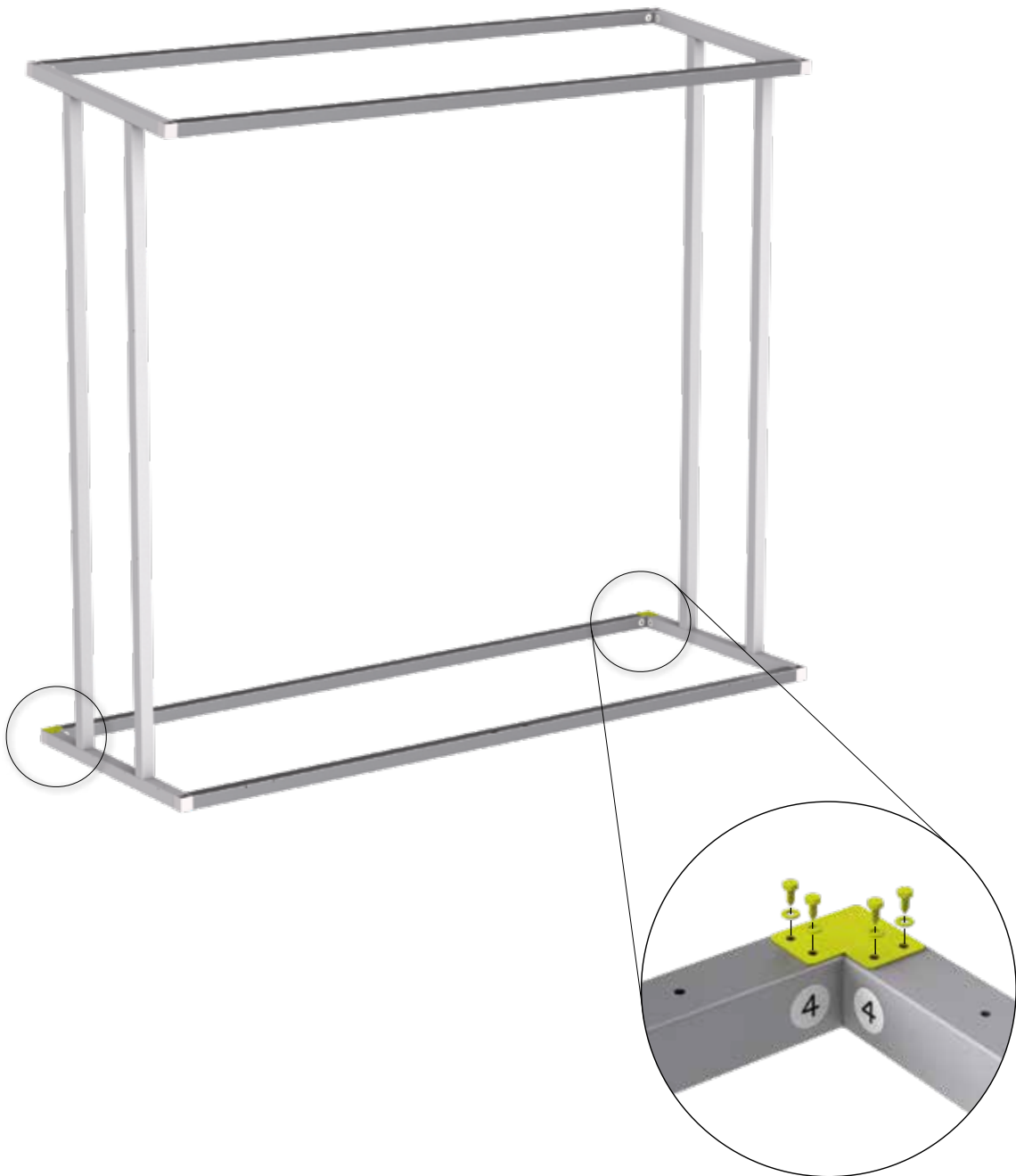



# 3.

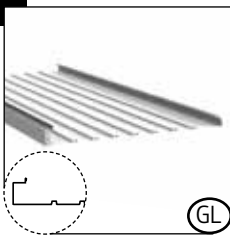

150: 1X  
230: 1X

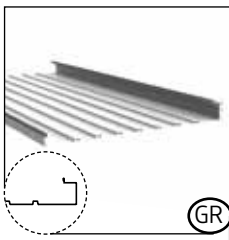

150: 1X  
230: 1X

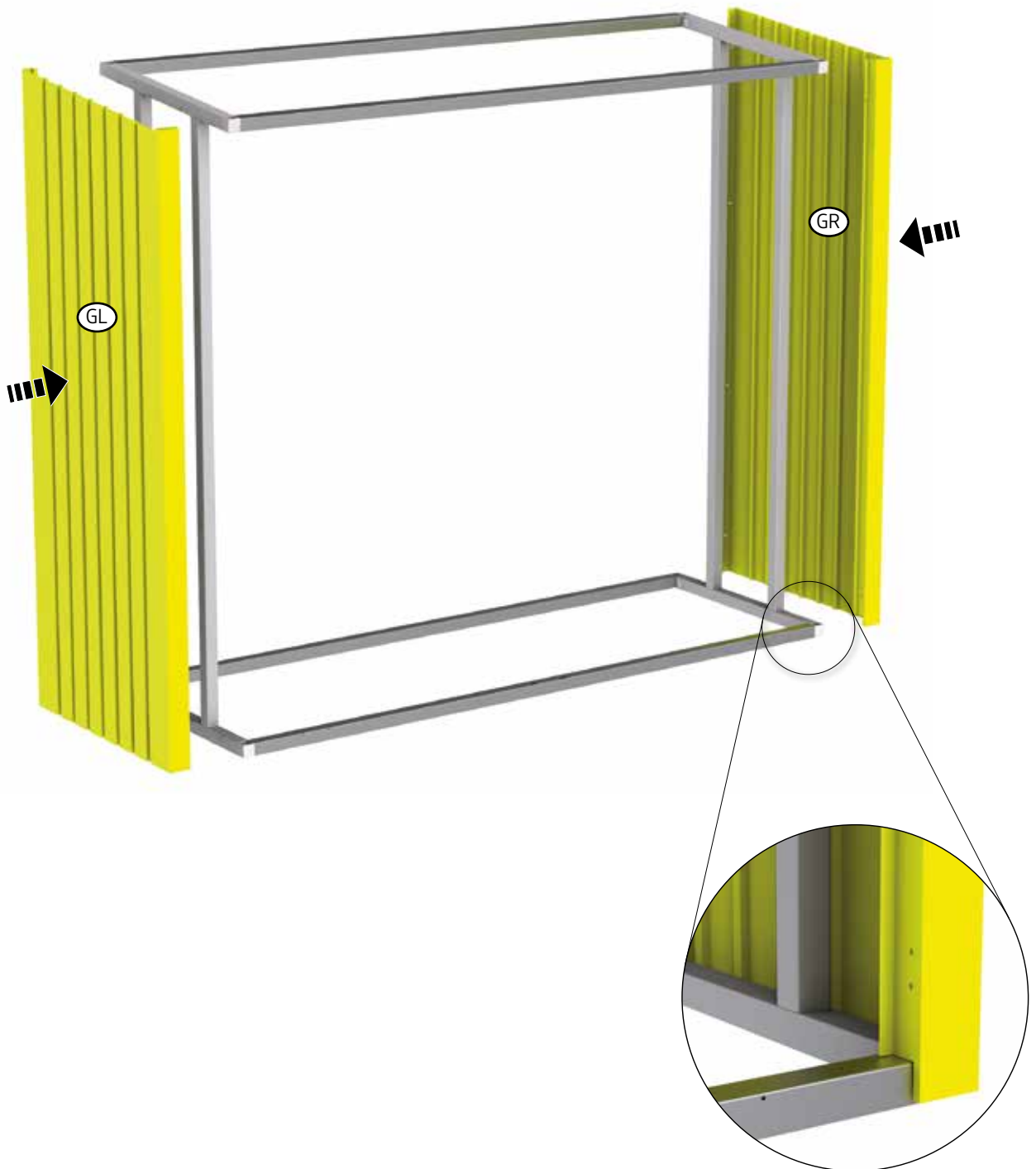



# 4.

4,2 x 13



150: 24x  
230: 24x



D1

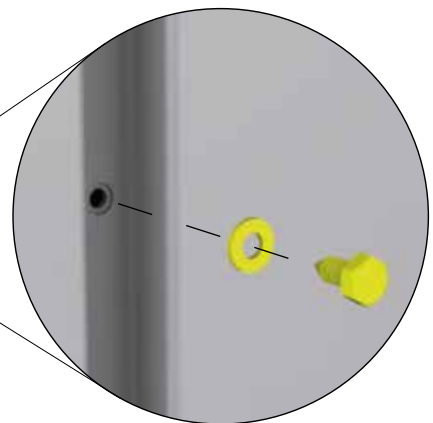
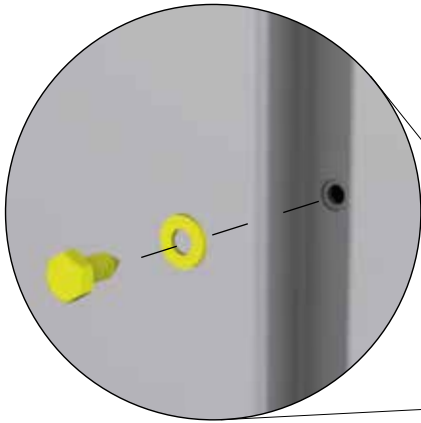

# 5.

## Ansicht Rückseite

Back side view - Vue arrière - Rugaanzicht - Vista trasera - Vista posteriore - Se bagside

4,2 x 13



150: 4X  
230: 4X

D1



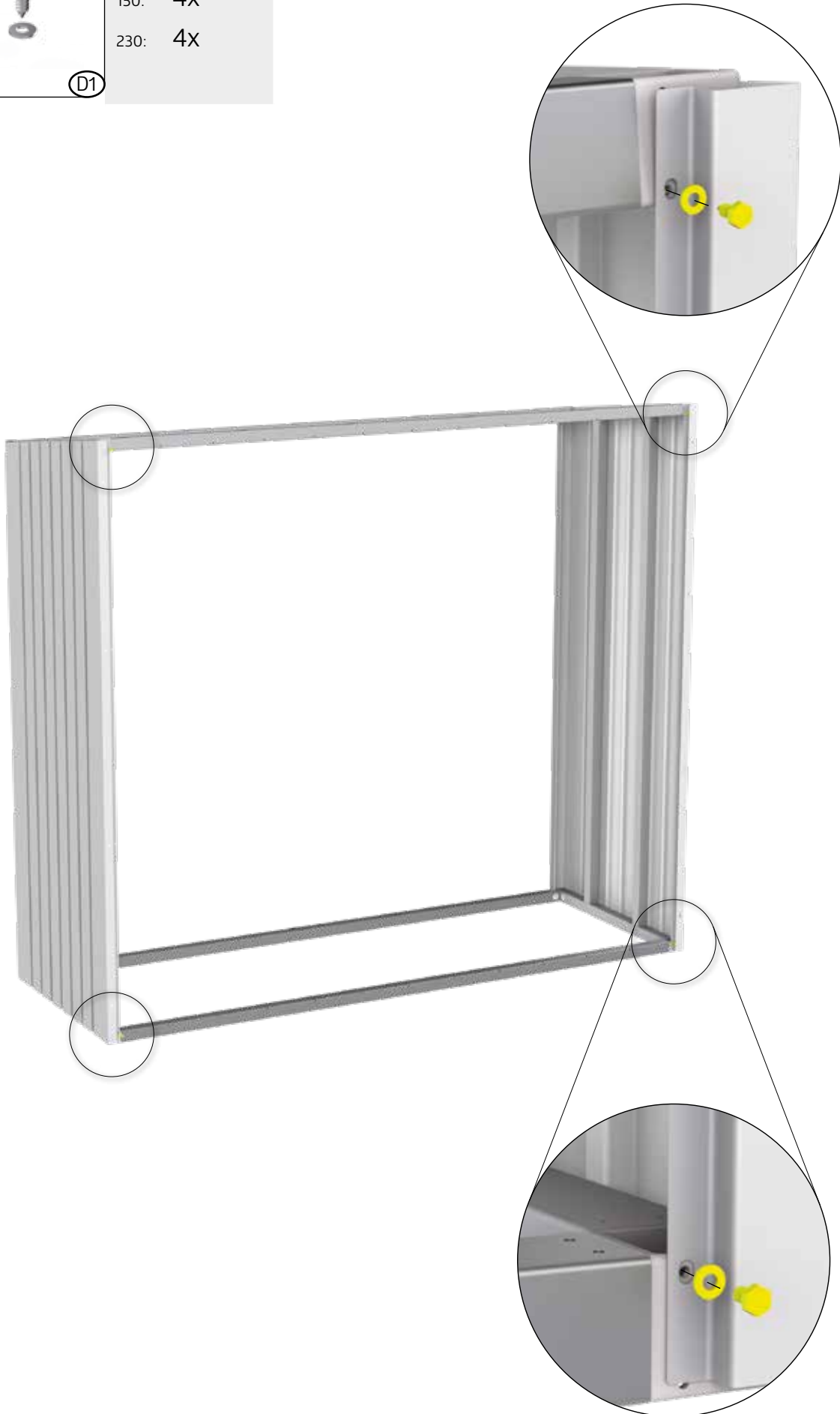



1



# 6.

## Ansicht Rückseite

Back side view - Vue arrière - Rugaanzicht - Vista trasera - Vista posteriore - Se bagside

 (KL)	 150: 1X 230: 1X	 (KR)	 150: 1X 230: 1X	 4,2 x 13 (D1)	 150: 6X 230: 6X
---	---	---	---	---	---

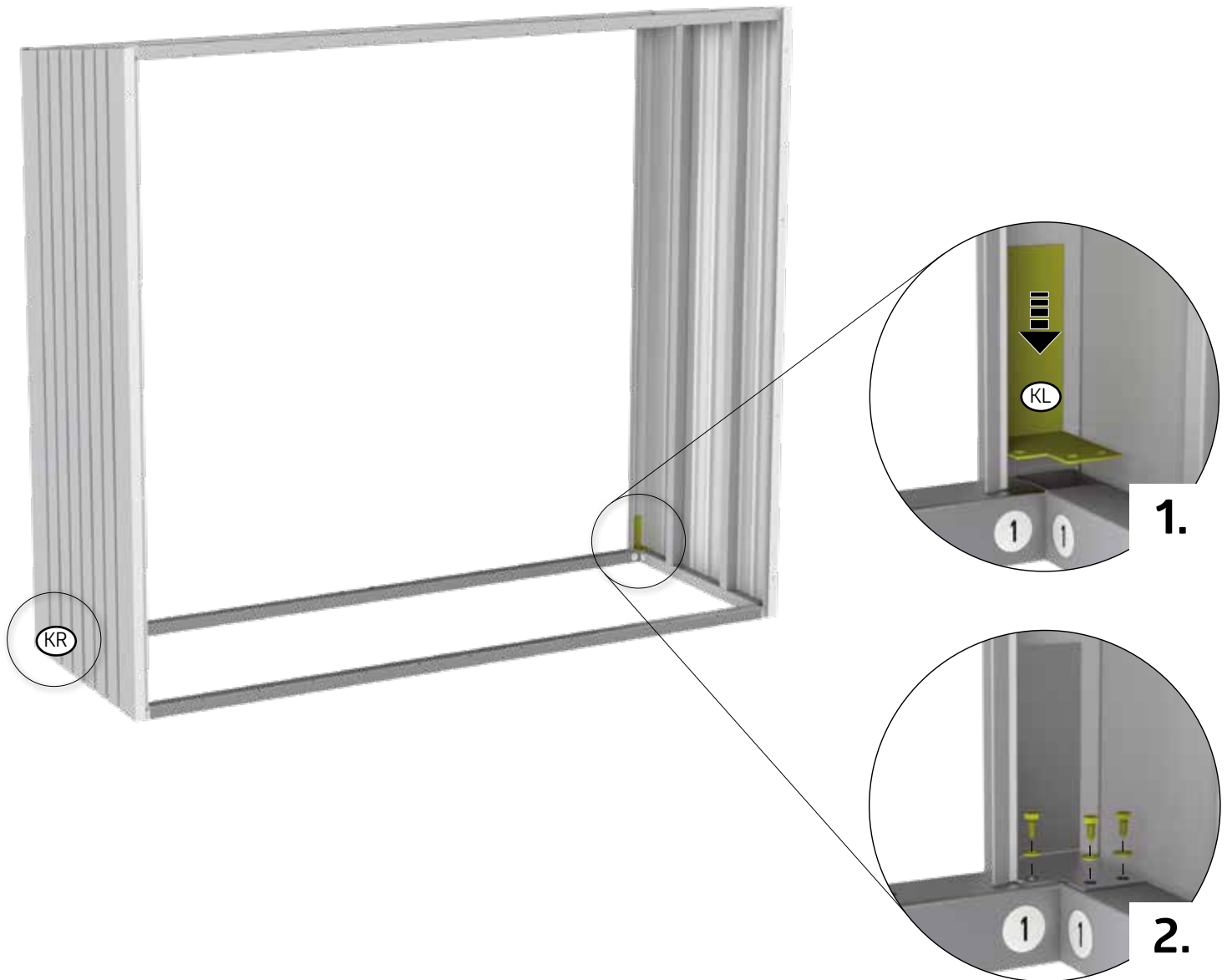

# 7.

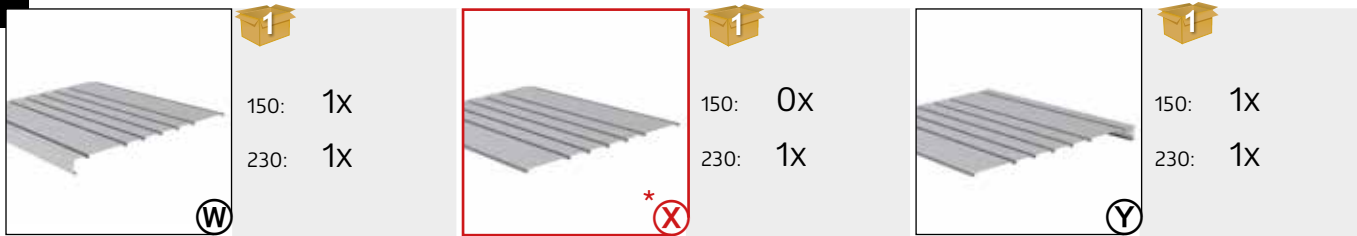

\* Nur für Größe 230

- GB Only for size 230
- FR Uniquement pour les taille 230
- NL Alleen voor grootte 230
- ES sólo para los tamaños 230
- IT solo per misura 230
- DK Kun for størrelse 230

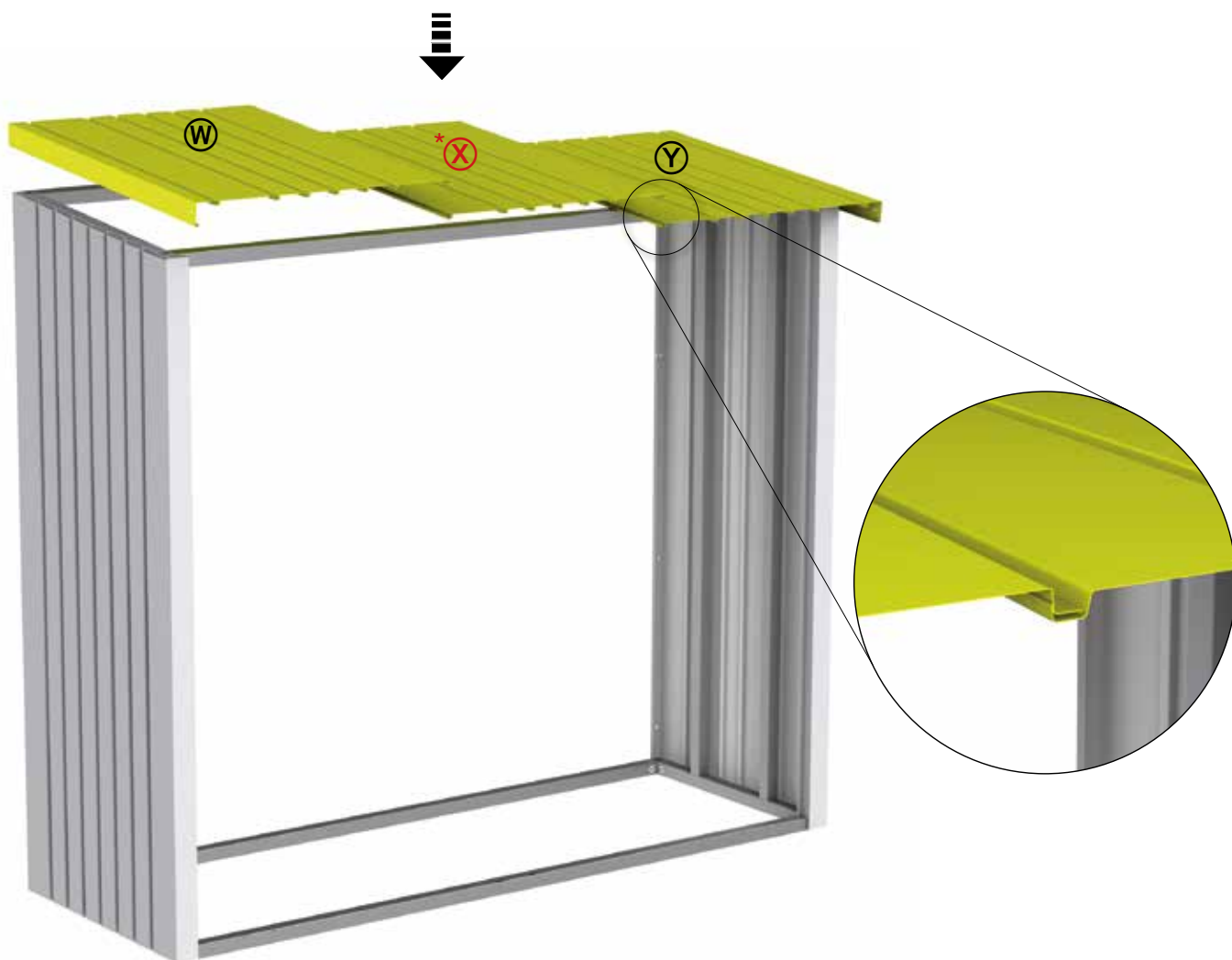

4,2 x 13



(D1)



150: 14x  
230: 20x

M4 x 10







(D1)

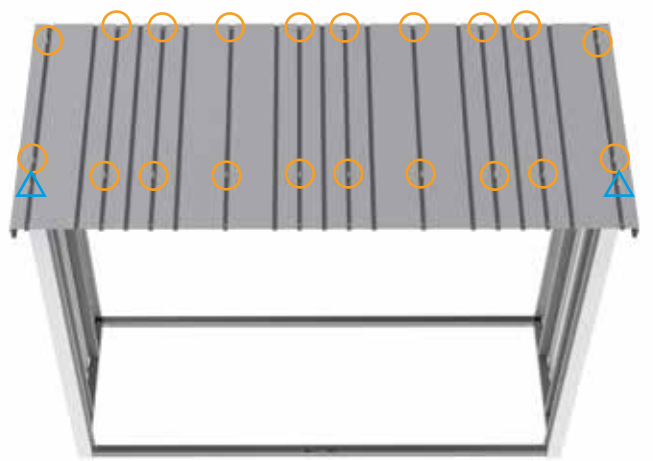
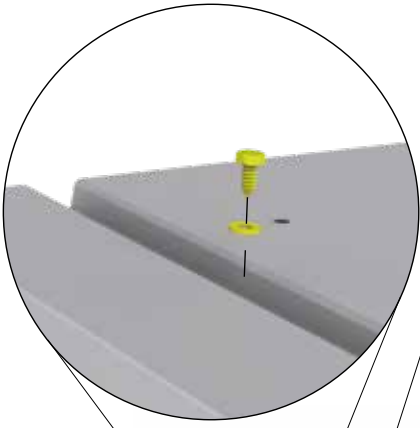

150: 2x  
230: 2x



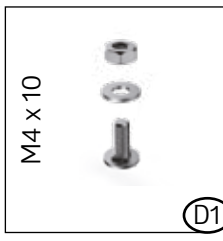

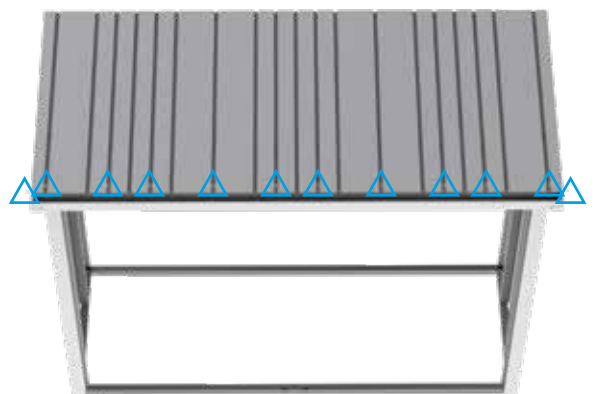
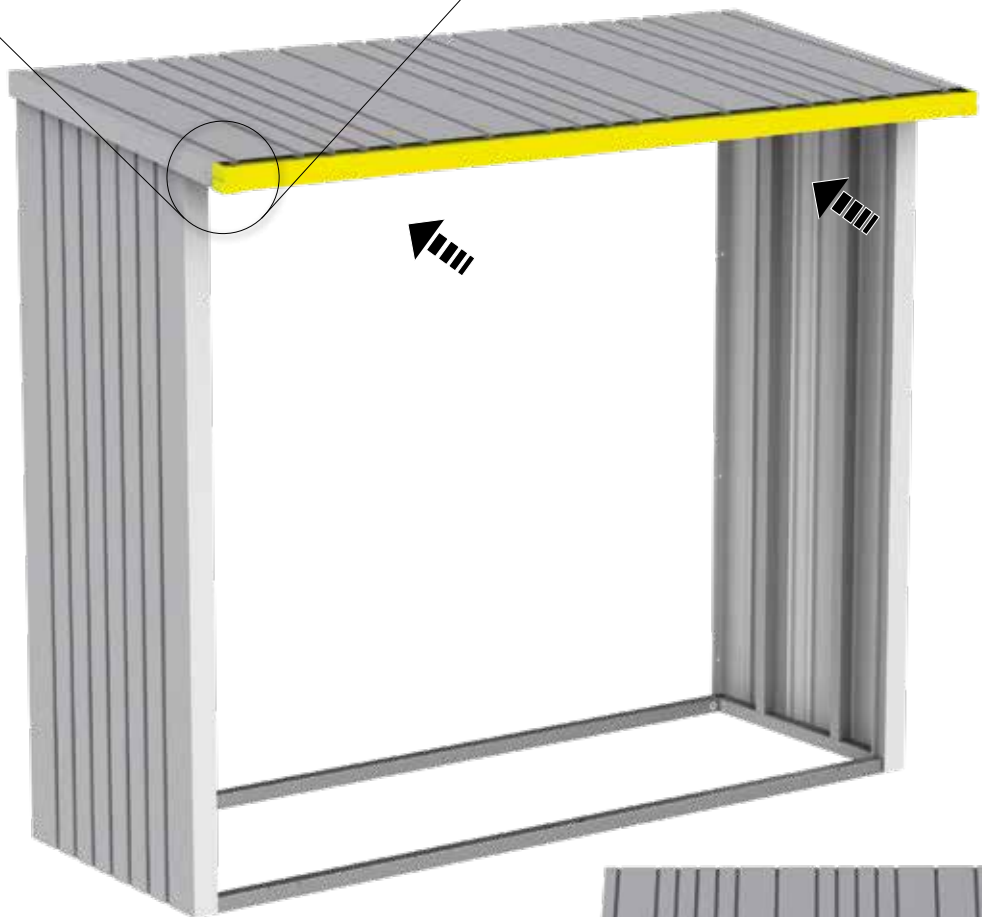
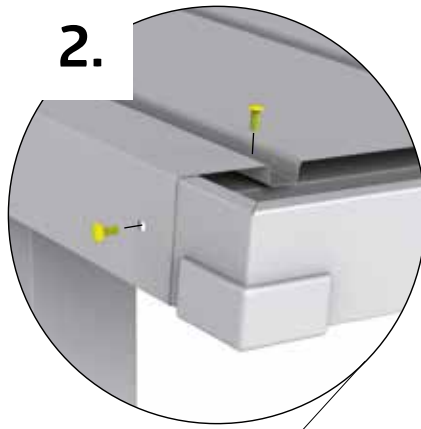
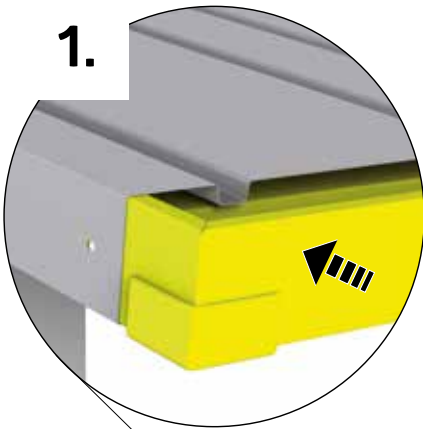

# 9.

	 150: 1X 230: 1X	 M4 x 10	 150: 9X 230: 12X
---	---	--	---



# 10.

					
	150:	1X		150:	1X
	230:	1X		230:	1X
(MA)		(MB)			

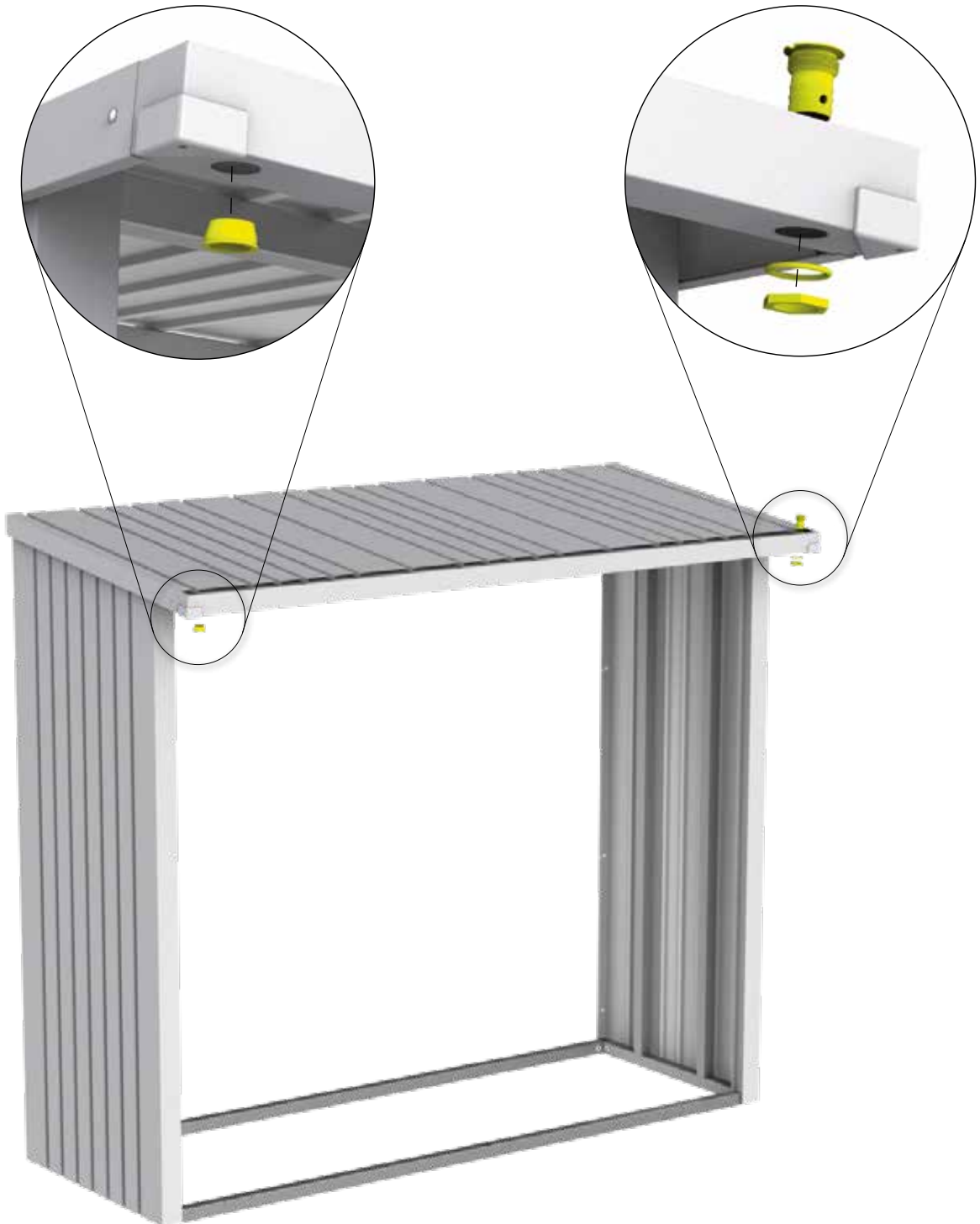







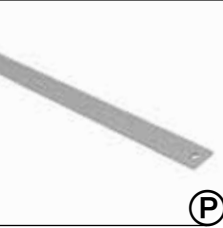

# 11.

## Ansicht Rückseite

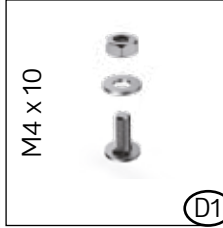
Back side view - Vue arrière - Rugaanzicht - Vista trasera - Vista posteriore - Se bagside



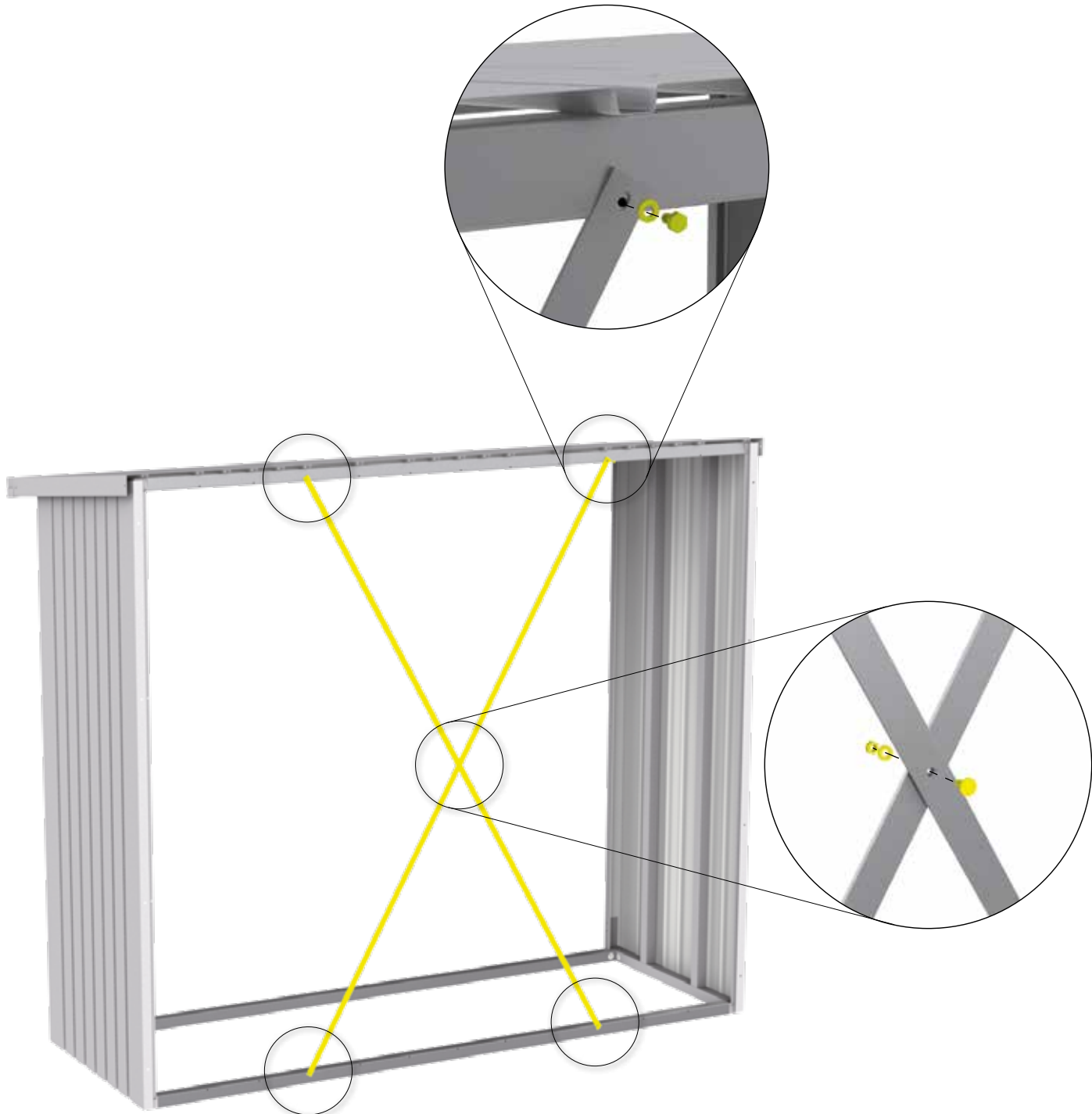



 Ⓟ	 150: 2X 230: 2X	 4,2 x 13 ⓁD1	 150: 4X 230: 4X	 M4 x 10 ⓁD1	 150: 1X 230: 1X
--	---	--	---	---	---

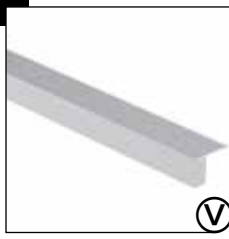

# 12.

## Ansicht Rückseite

Back side view - Vue arrière - Rugaanzicht - Vista trasera - Vista posteriore - Se bagside

 V	 150: 1X 230: 1X	 4,2 x 13 D1	 150: 2X 230: 2X	 M4 x 10 D1	 150: 4X 230: 6X
--	---	---	---	--	---

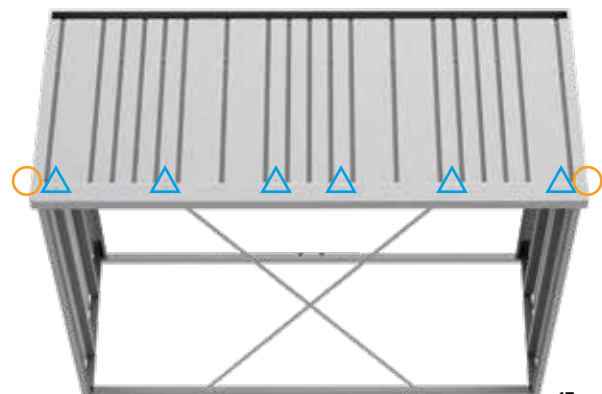
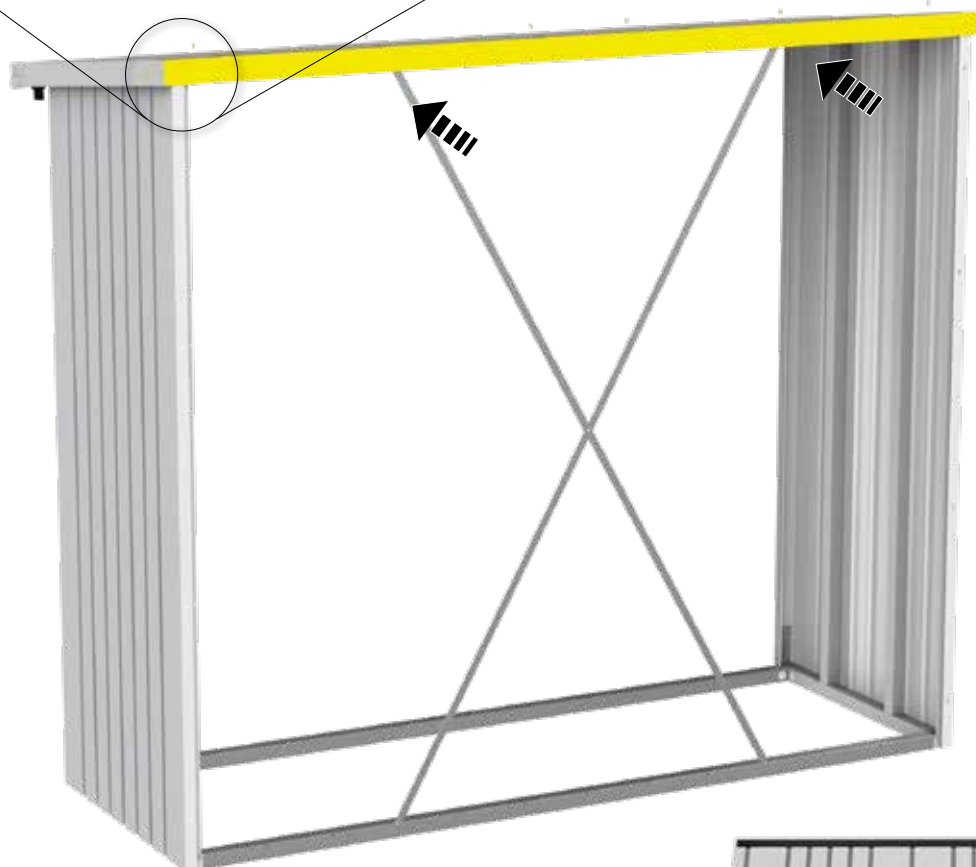
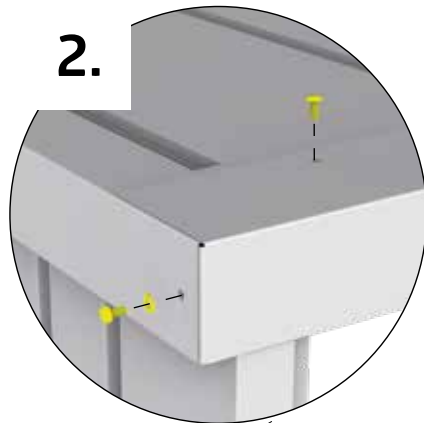
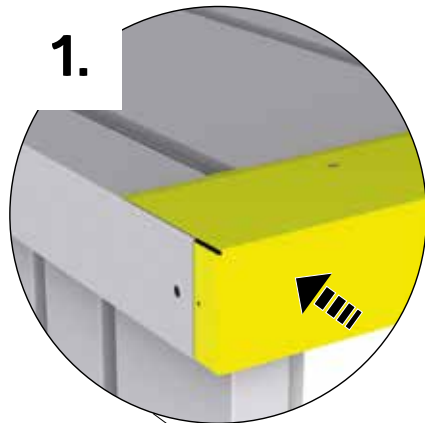

# 13.

## Ansicht Rückseite

Back side view - Vue arrière - Rugaanzicht - Vista trasera - Vista posteriore - Se bagside

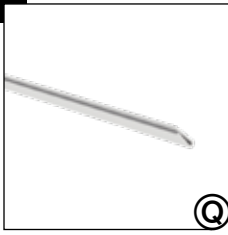

150: 2x

230: 2x

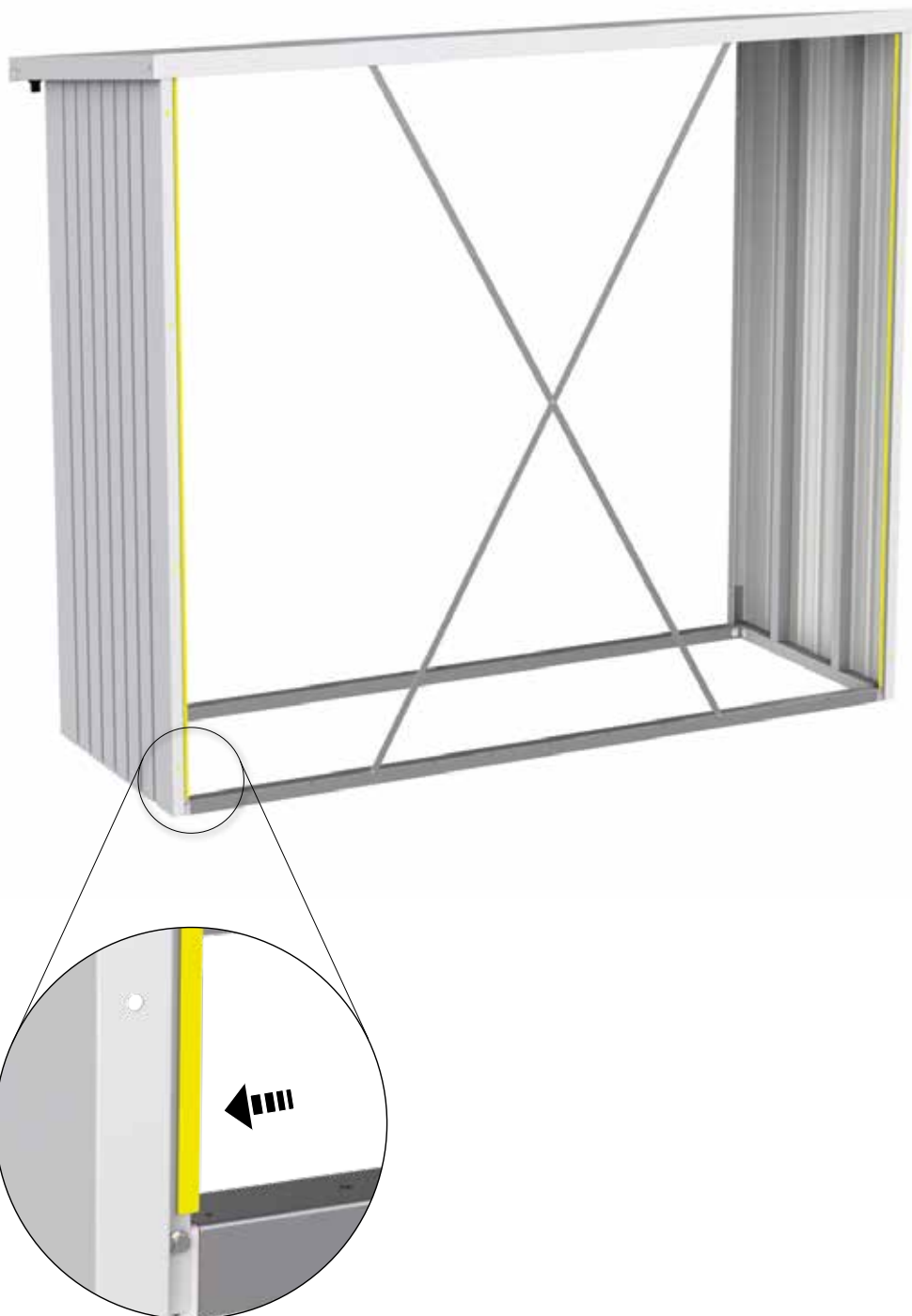

# 14.

M4 x 10



1

150:	12X
230:	12X

D1

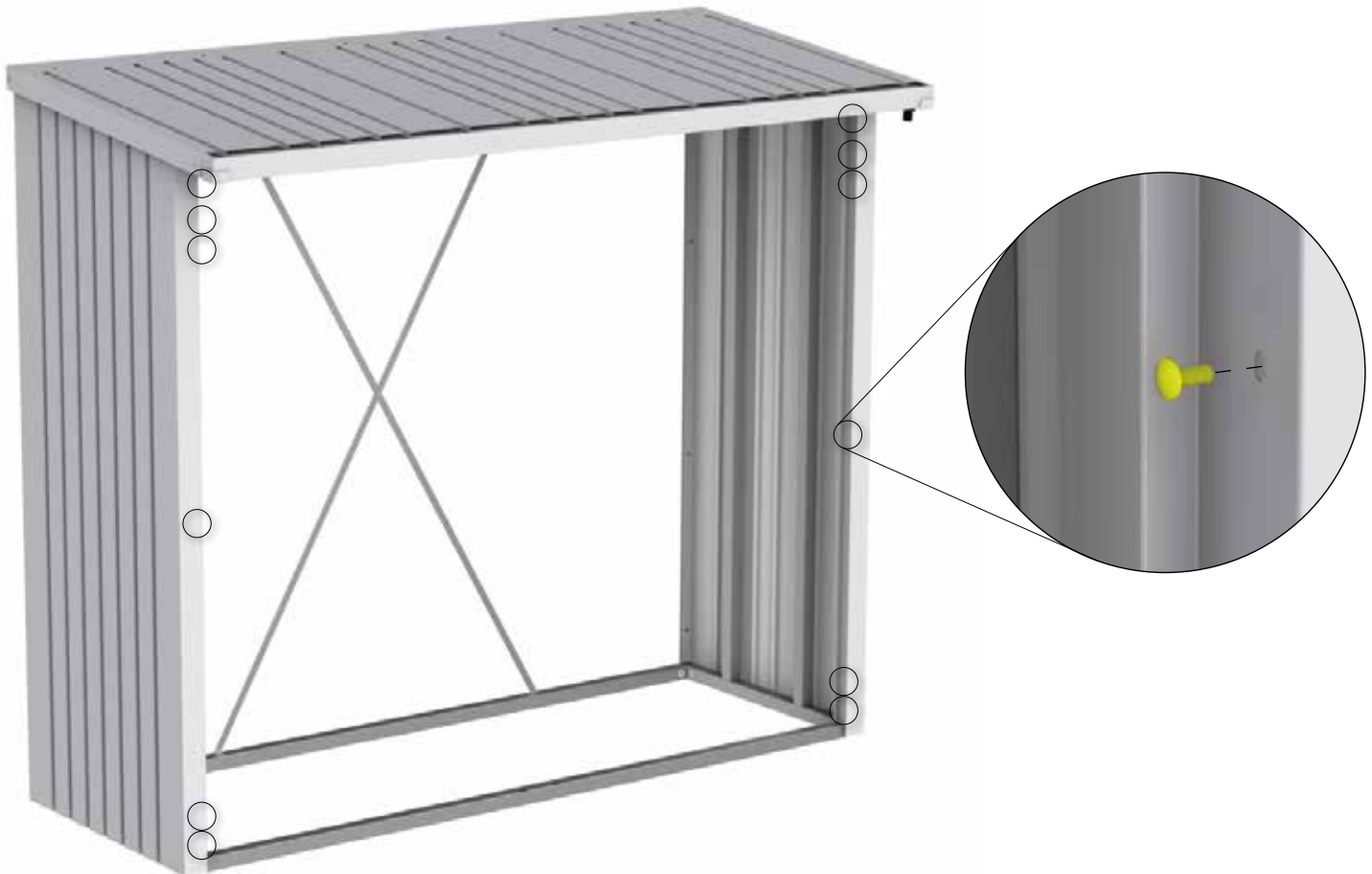

**!** **Ziehen Sie jetzt alle Schraubverbindungen fest an!**  
Tighten now all nuts and connections securely! - Serrez maintenant les vis à fond! - Draai nu alle schroeven vast! - Ahora puede apretar y fijar todos los tornillos y tuercas - Adesso serrare a fondo tutti i dadi - Fastspænd nu alle bolt-/skrueforbindelser!

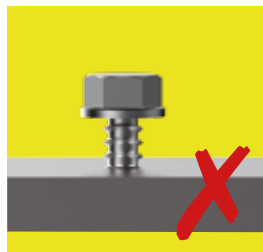
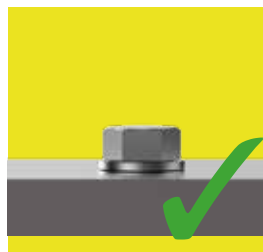

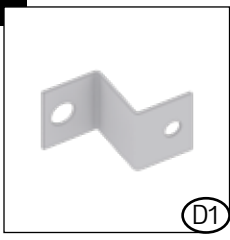

**1**

150: 6X  
230: 6X

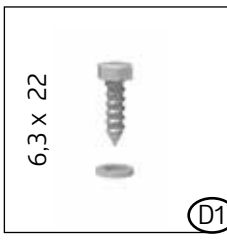

**1**

150: 6X  
230: 6X

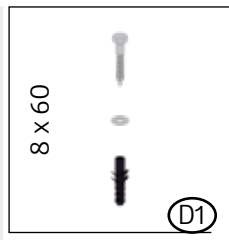

**1**

150: 6X  
230: 6X

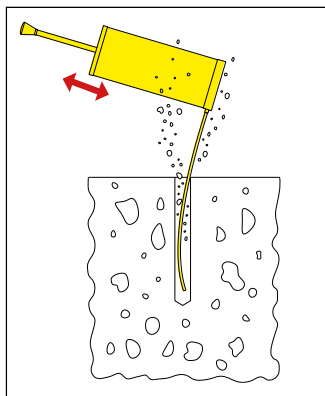
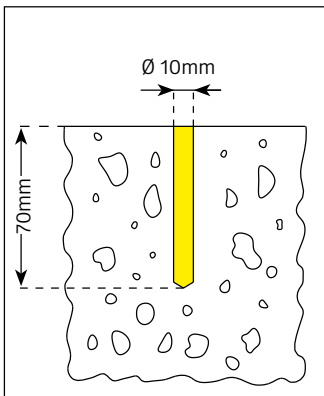
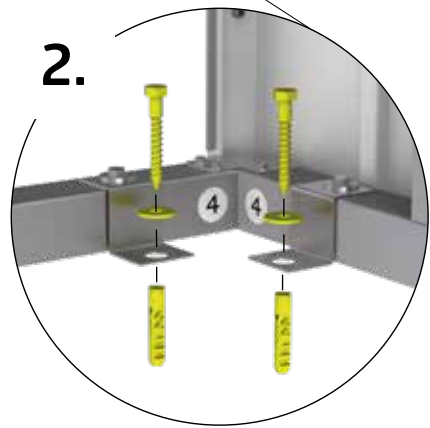
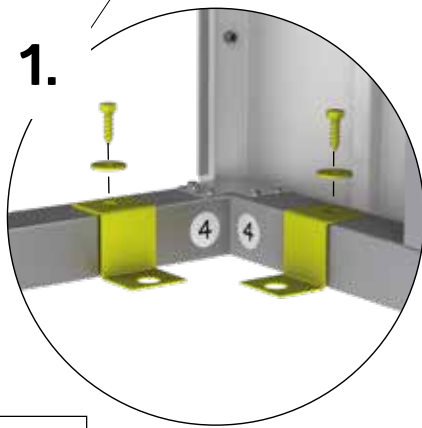
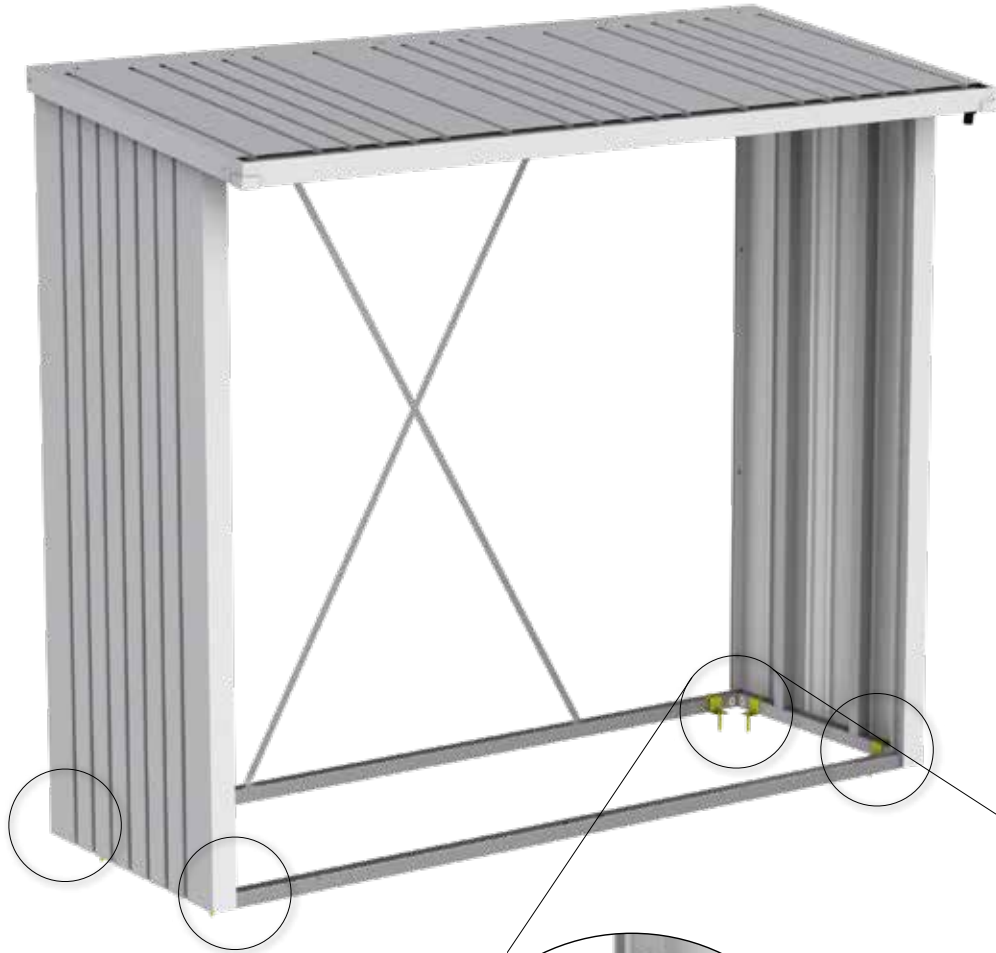











**GERÄTEHÄUSER** – Setzen Sie auf Qualität & Langlebigkeit  
**GARDEN SHEDS** – rely on quality & longevity



**GARTENBOXEN** – Outdoorboxen für Garten, Terrasse & Co.  
**OUTDOOR BOXES** – outdoor boxes for garden, patio & more



**FAHRRAD-GARAGEN** – Fahrräder, Roller & Co sicher verstaut  
**BICYCLE STORAGE** – for safe storage of bicycles, scooters & more



**MÜLLTONNEN-BOXEN** – Stylish, praktisch & wartungsfrei  
**DUSTBIN STORAGE** – stylish, practical & maintenance free



**GARTEN-HELFER** – Gartendesign in Bestform  
**GARDENING HELPERS** – garden design at its best



Biohort steht für  
**„LEBEN IM GARTEN“**

Biohort stands for  
**„LIFE IN THE GARDEN“**

**Kontrollnummer:**

Control-number / Contrôle-Qualité / Controlnummer:

**Bei Reklamationen bitte anführen:**

**Kontrollnummer und Artikelnummer des reklamierten Teils.**

GB: In case of complaint please indicate the control-number and the number of the item, which is subject of complaint.

F: Pour toutes réclamations: prière de joindre le numéro de contrôle et le numéro d'article de la pièce litigieuse.

NL: Bij reclamaties svp doorgeven: controlnummer en artikelnummer van het desbetreffende onderdeel.

follow us:



**Biohort GmbH**  
 Pürnstein 43, 4120 Neufelden, Österreich  
 Tel: +43-7282-7788-0  
 E-Mail: office@biohort.at, www.biohort.com