

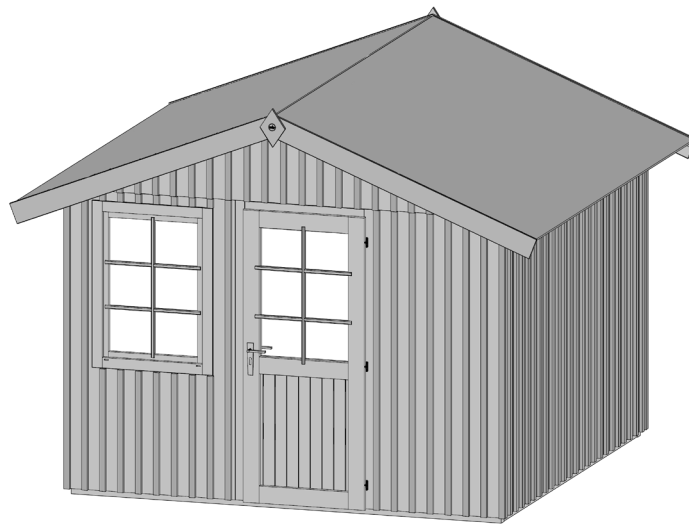

www.weka-holzbau.com



## Schwedenhaus in Elementbauweise



410.3030.20000  
410.3030.23000

### Montage-, Bedienungs- und Wartungsanleitung



800.0286.17.81

+



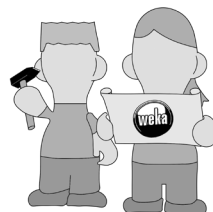

800.0286.20.02

=





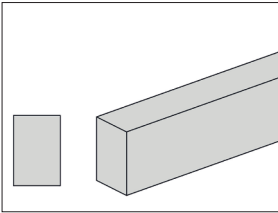
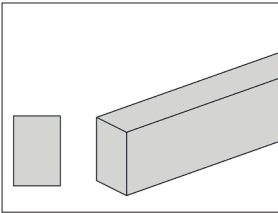
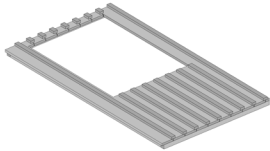

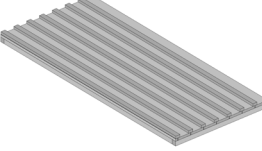
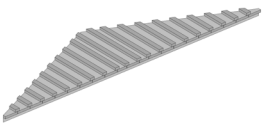

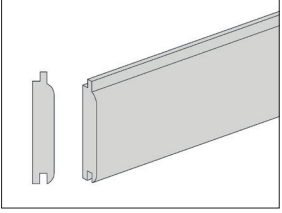
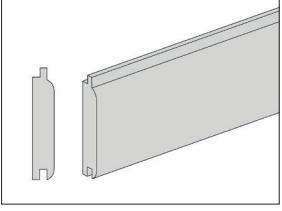
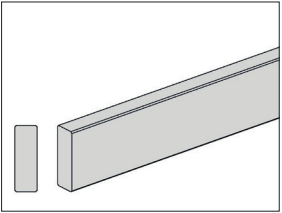
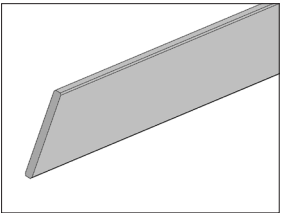
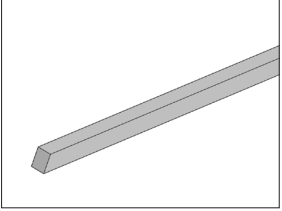
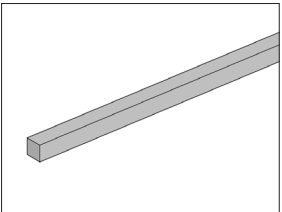

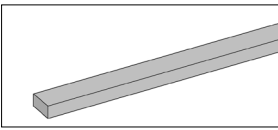
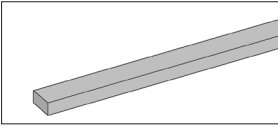
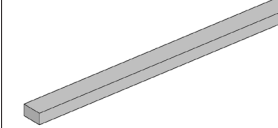
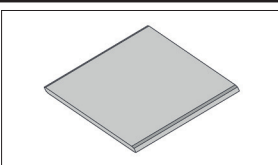
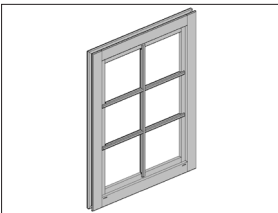

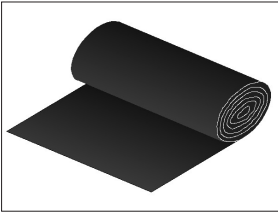
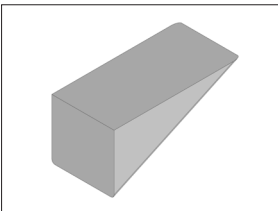

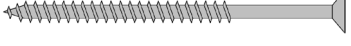
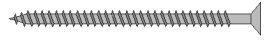
Jetzt  
scannen  
und noch  
mehr entdecken!

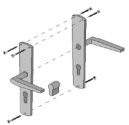

Pos	Bild	Abmessung ( mm )	Anzahl ( Stück)
			410.2525.2x001
①	R002.0650.3000 	40/60/3000	2
②	R002.0650.2830 	40/60/2830	6
③	B410.01.0002 B410.01.0802 	82/1167/2030	1
④	B410.01.0003 B410.01.0803 	82/725/2030	6
⑤	B410.01.0008 B410.01.0808 	82/770/2030	6
⑥	B410.01.0007 B410.01.0807 	82/897/2030	1
⑦	B410.01.0009 B410.01.0809 	82/625/3030	2

Pos	Bild	Abmessung ( mm )	Anzahl ( Stück)
			410.2525.2x001
8	B410.01.0010 	82/638/3030	3
9	R002.0162.2910 	18,5/96/2910	33
10	R002.0162.3344 	18,5/96/3344	46
11	R002.0530.1775 	15/45/1775	4
12	G410.01.0002 G410.01.1002 	18,5/146/1945	4
13	G410.01.0005 	30/30/1710	4
14	G410.01.0004 	28/28/2030	2

Pos	Bild	Abmessung ( mm )	Anzahl ( Stück)
			410.2525.2x001
15	G410.01.0008 G410.01.0808 	30/60/2870	2
16	G410.01.0009 G410.01.0809 	30/60/3030	2
17	G410.01.0010 G410.01.0810 	22/40/2030	17
18	G100.10.0001 G100.10.1001 	18.5/160/260	2
19	B100.11.3410 B100.11.3470 	53/842/1134	1
20	B100.12.6430 B100.12.6470 	63/965/2030	1
21	100.1006.00.00 	-	1
22	G410.01.0012 	41/40/104	6

<b>M410.001 410.2525.2x001</b>		<b>Abmessung ( mm )</b>	<b>Anzahl ( Stück)</b>
<b>Pos</b>	<b>Bild</b>		<b>410.2525.2x001</b>
<b>M1</b>	K001.1050.0004 	5,0 x 100	15
<b>M2</b>	K001.7045.0004 	4,5 x 70	250
<b>M3</b>	K010.6040.0004 	4,0 x 60	100
<b>M4</b>	K001.4040.0004 	4,0 x 40	260
<b>M5</b>	K001.3030.0004 	3,0 x 30	50
<b>M6</b>	K010.5022.0001 	2,2 x 55	770
<b>M7</b>	K011.1320.0001 	2,0 x 13	500
<b>M8</b>	K045.1270.0001 	-	1
<b>M9</b>	K036.3135.0001 	65	1
<b>M10</b>	K100.1010.0006 	2,0/50/50	1
<b>M11</b>	K004.9522.0006 	2,2 x 9,5	2

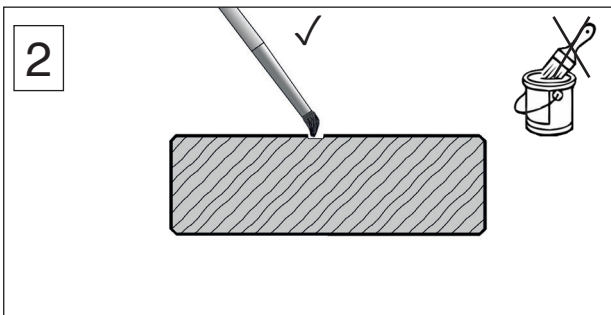
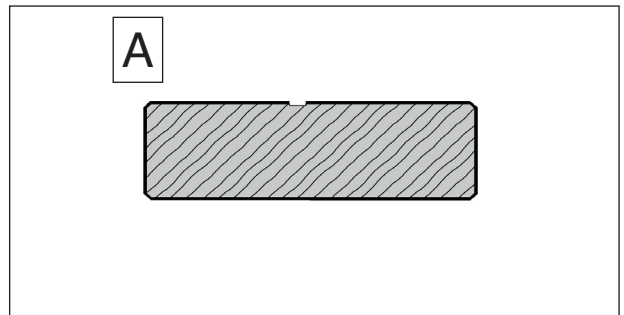
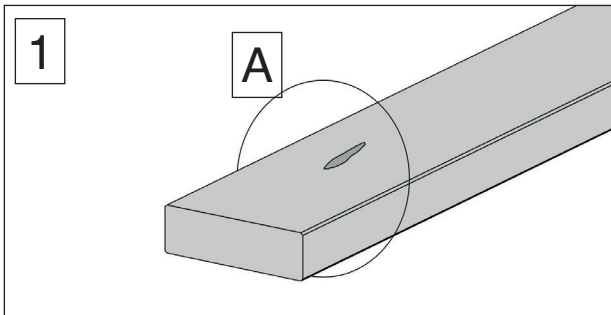
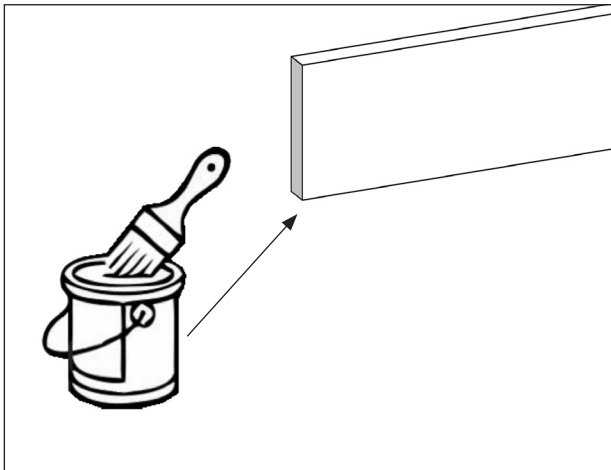
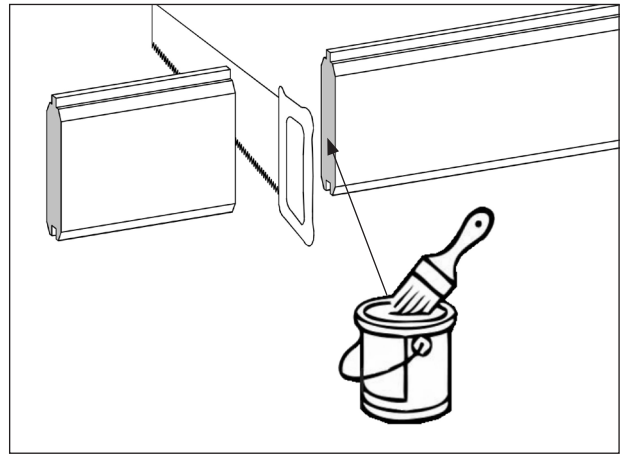
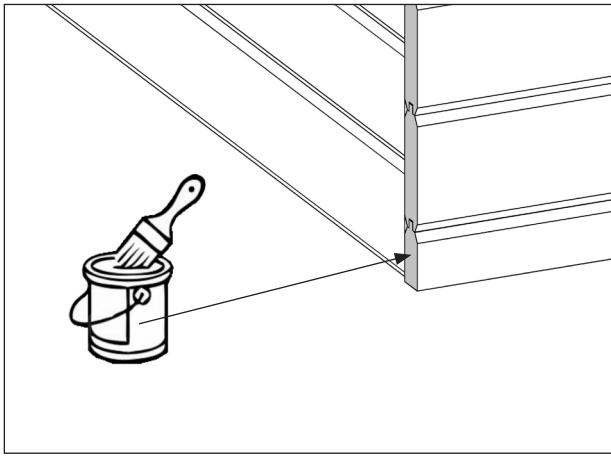

Farbe dünn auftragen und nur auf der Schadstelle.

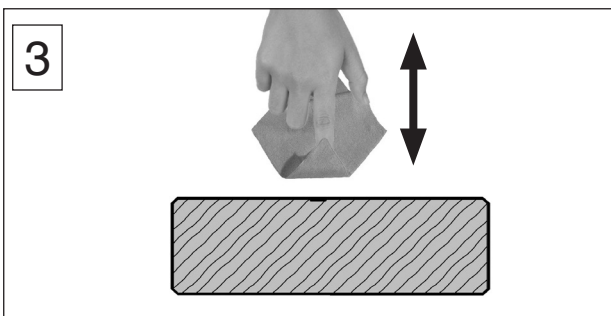
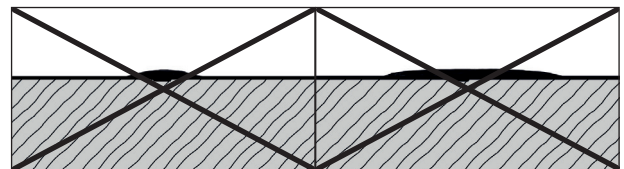

Farbe abtupfen.

Vorgang wiederholen bis die Farbe identisch ist.

# Übersicht

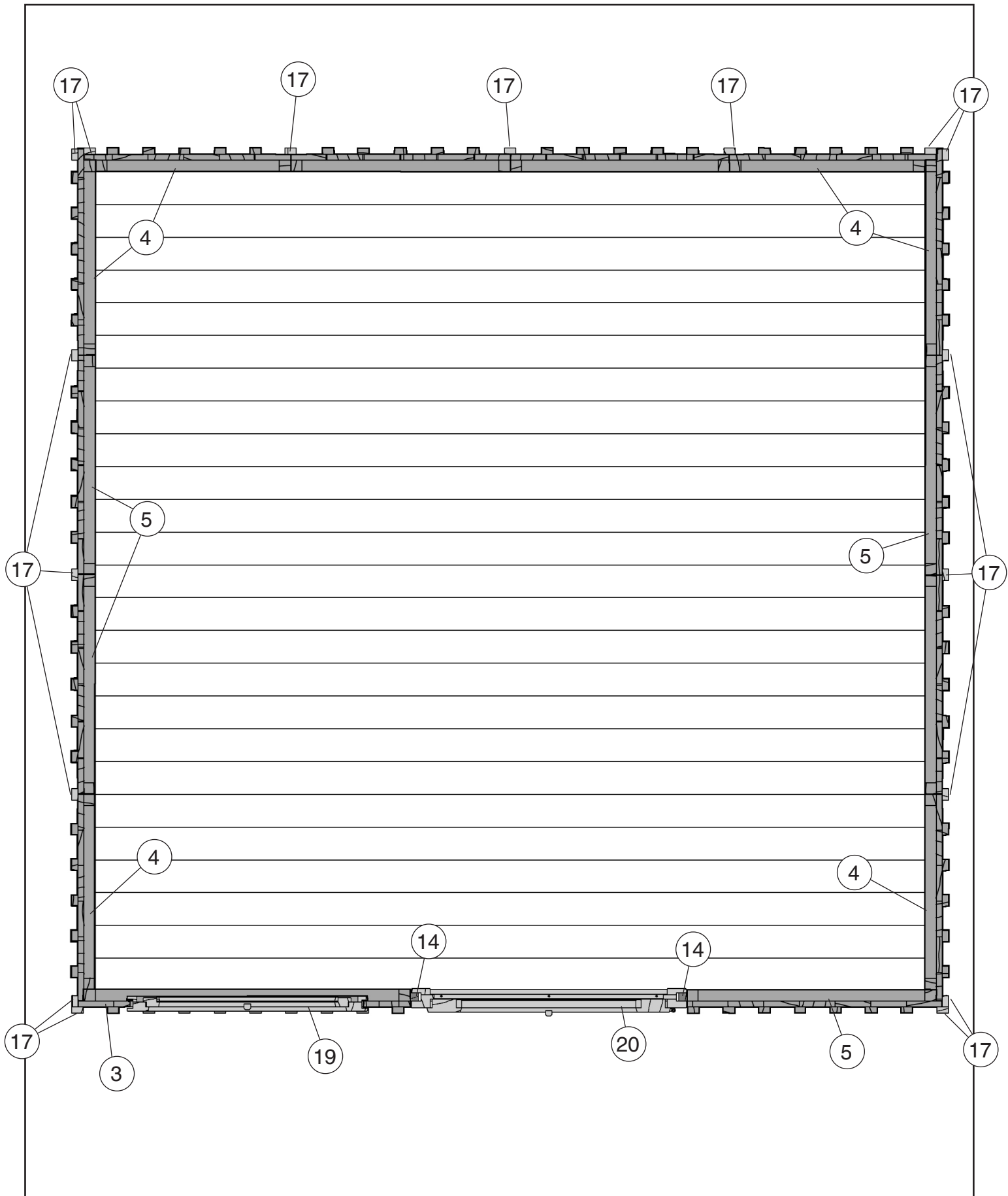

1

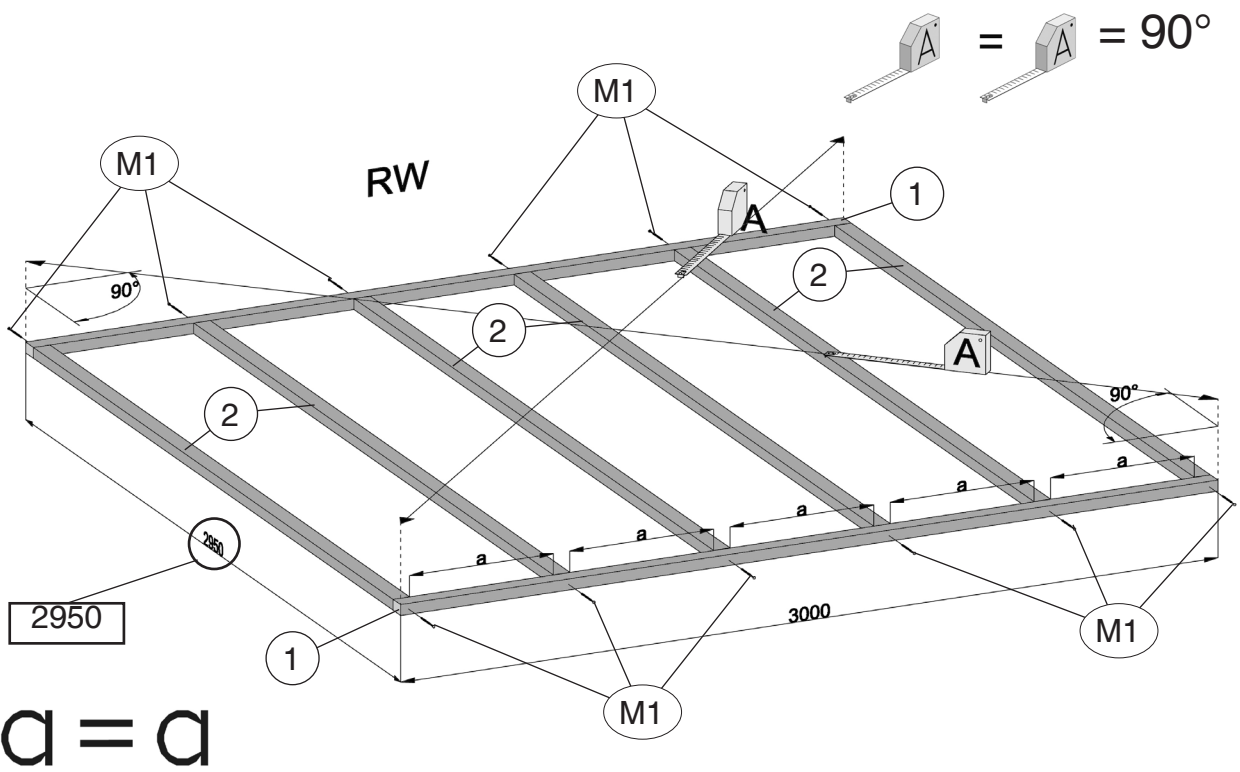
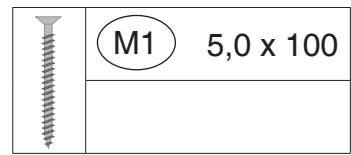

2

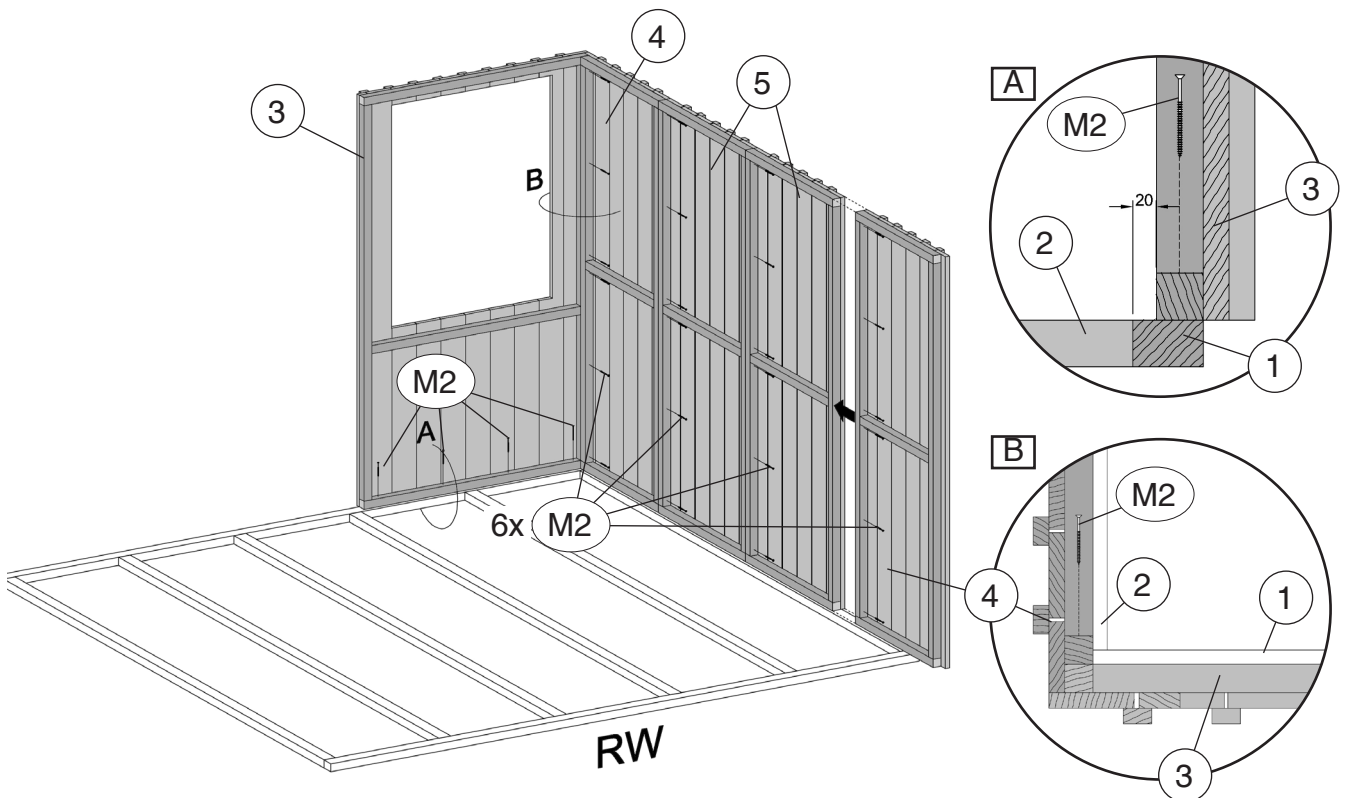
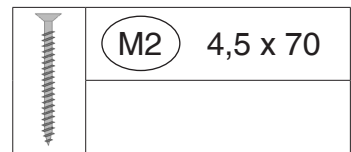



3

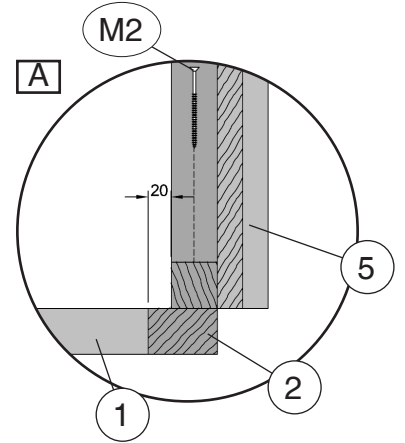
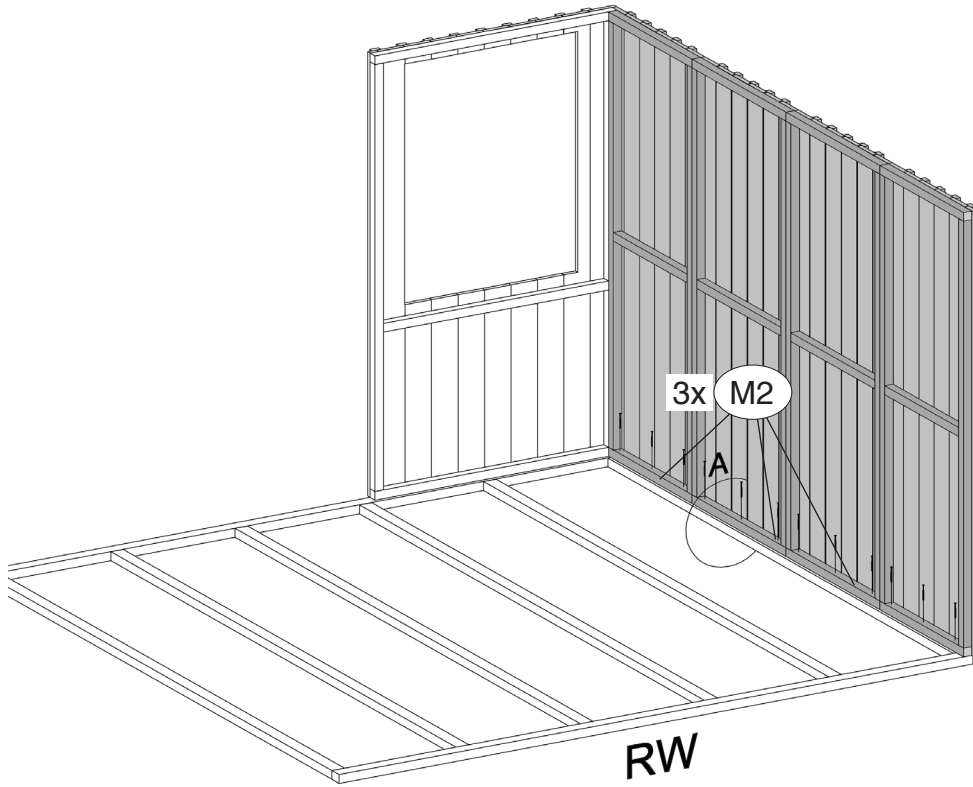
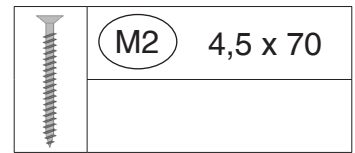

4

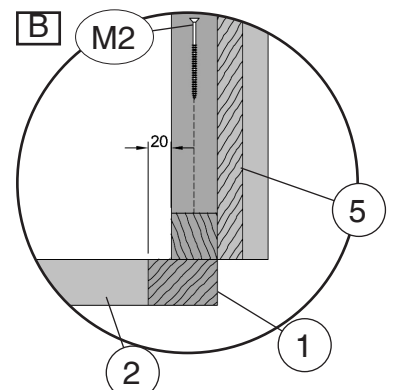
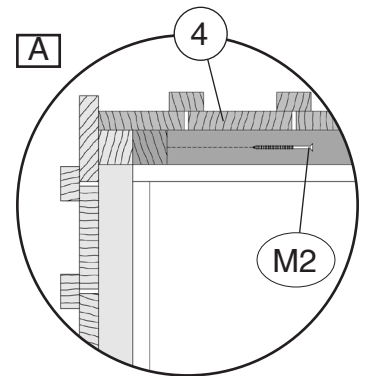
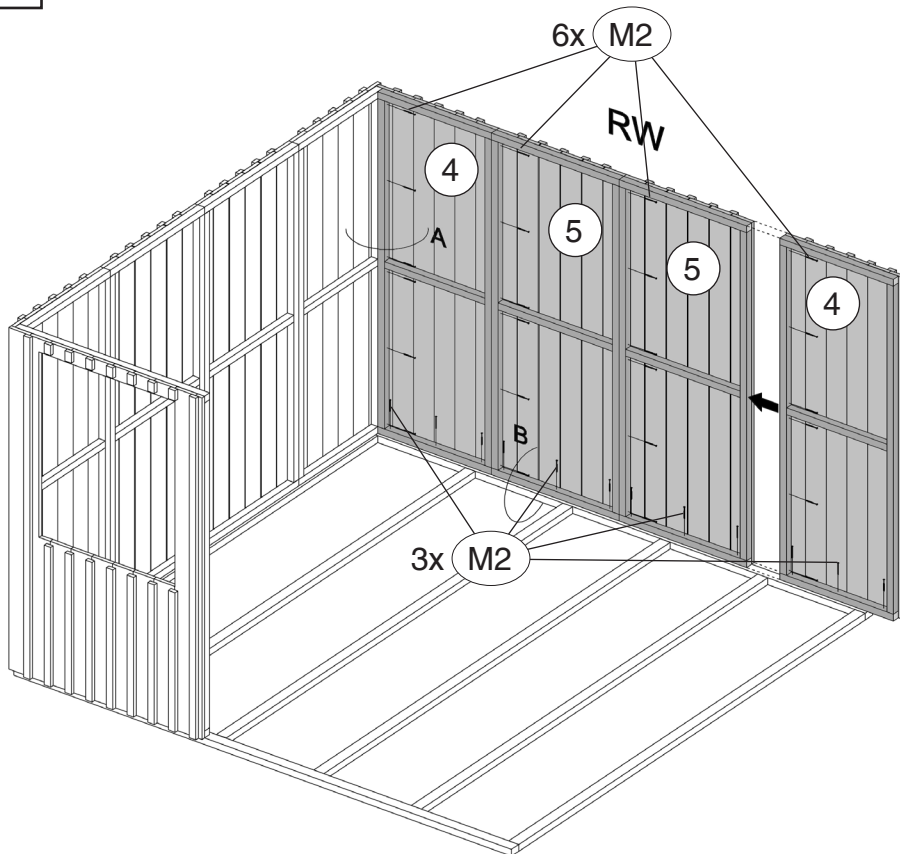
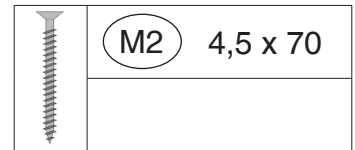

5

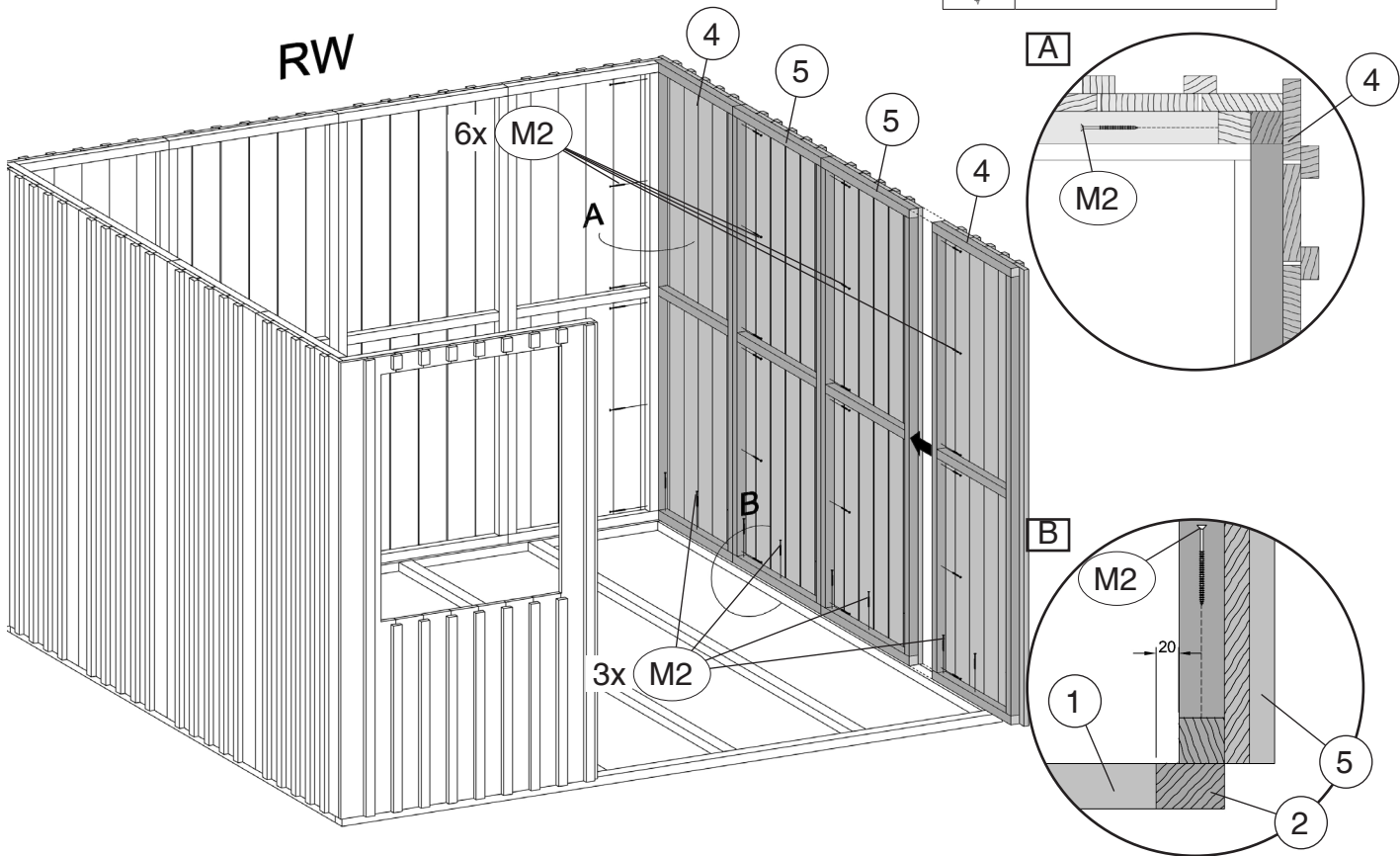
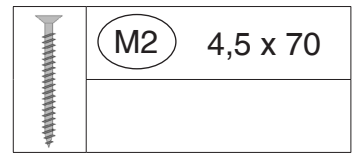

6

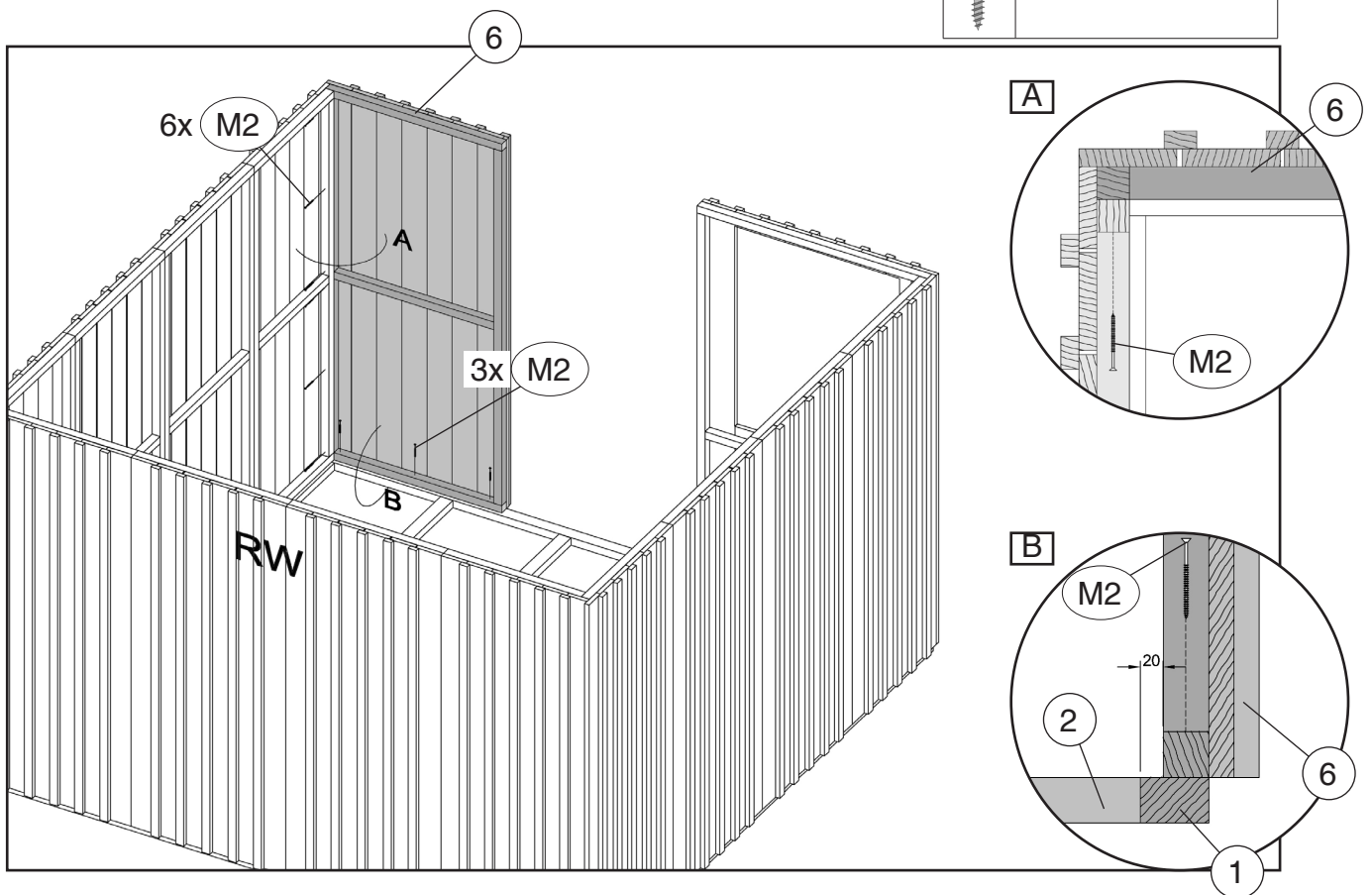
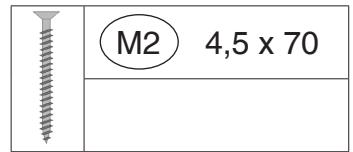

7

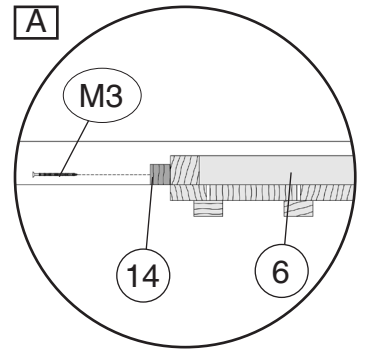
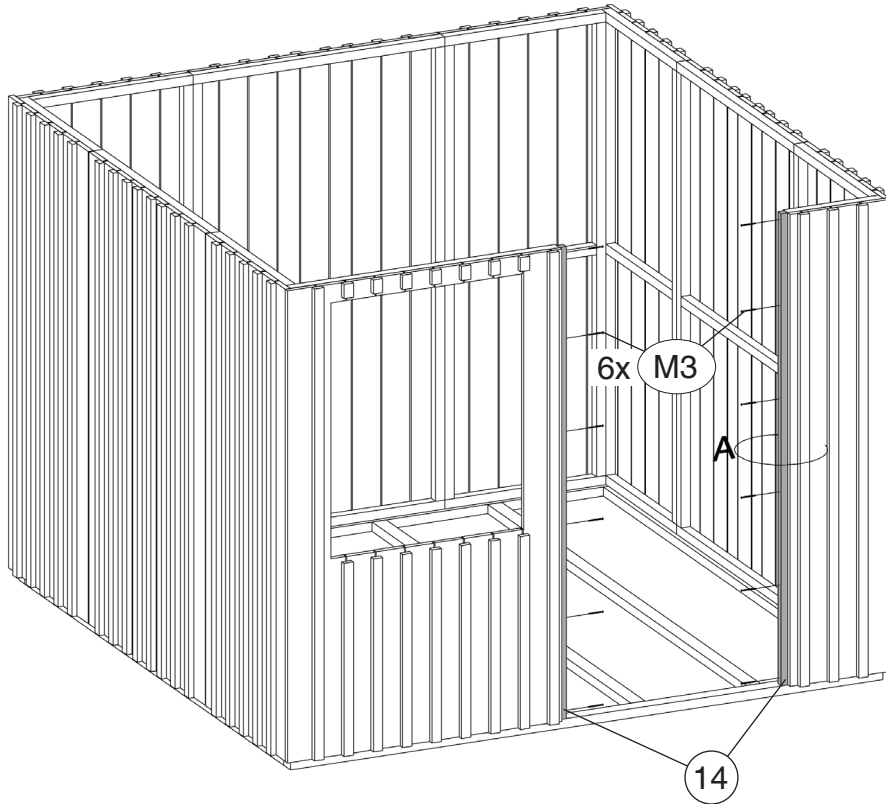
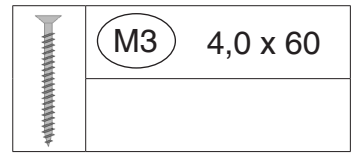

8

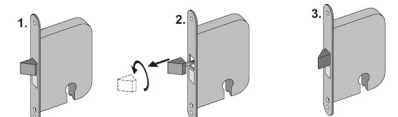
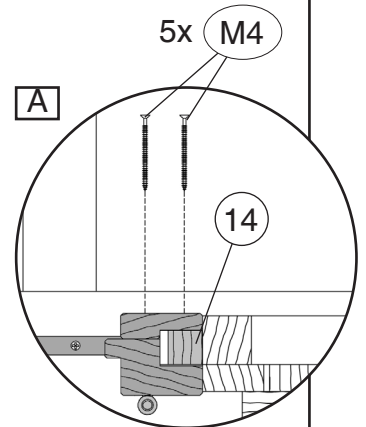
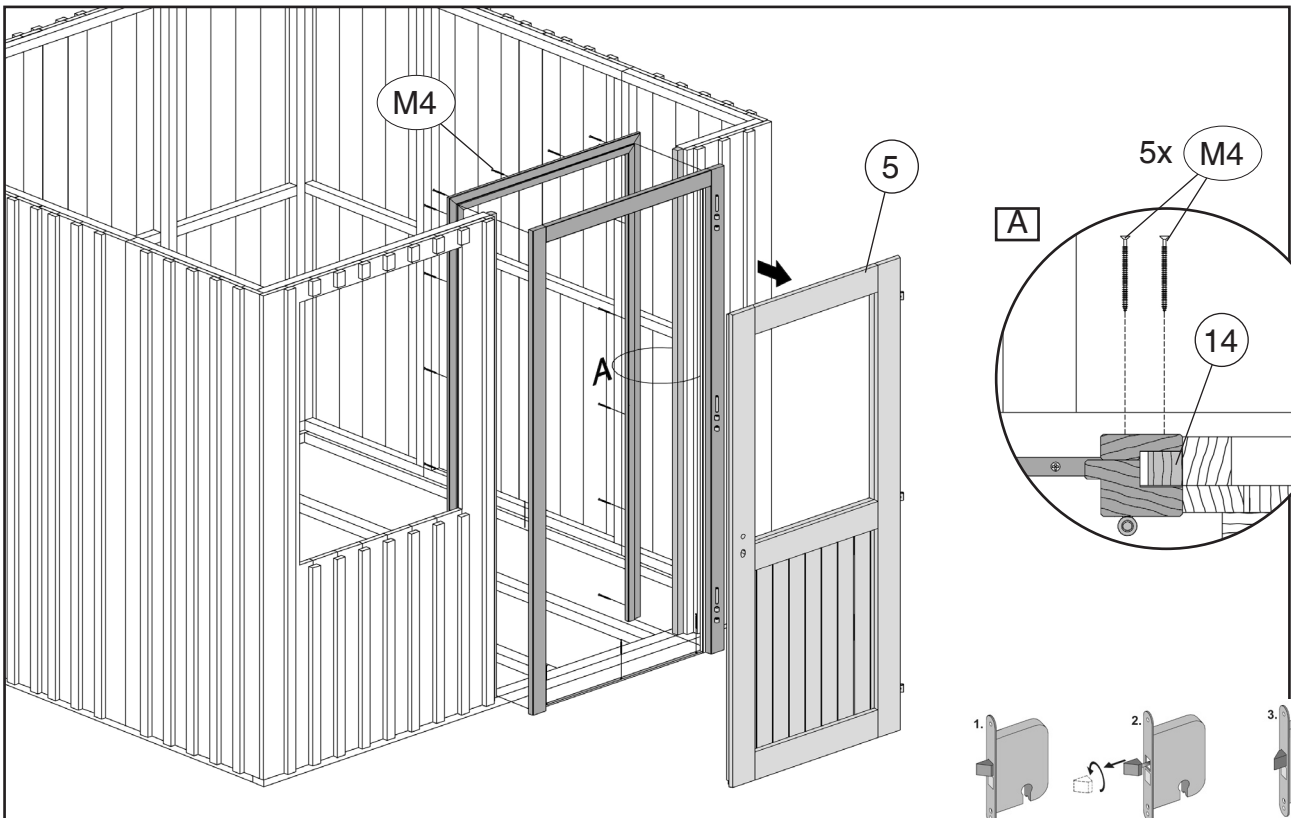
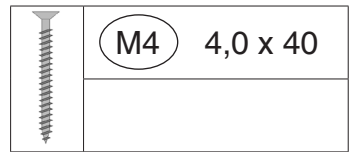

9

	M6 2,2 x 55
---	-------------

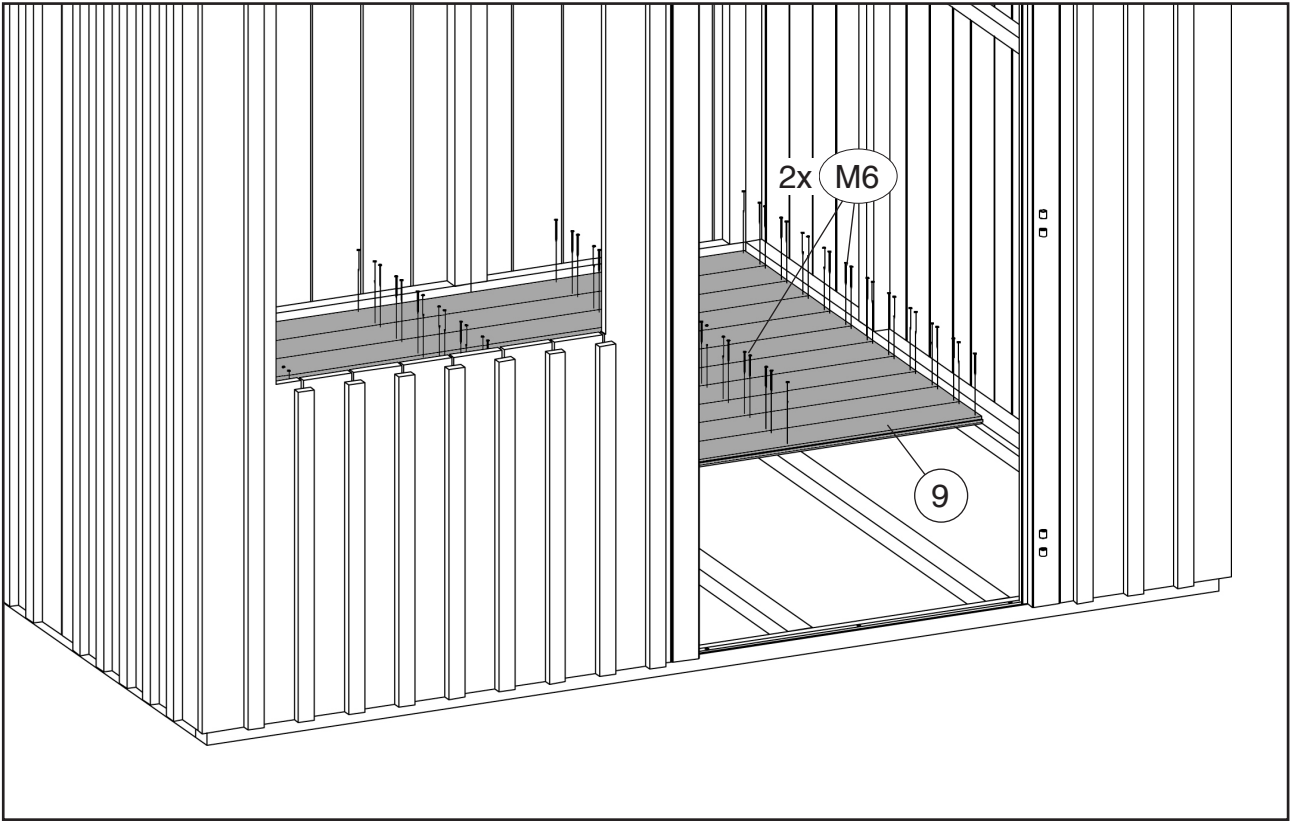

10

	M6 2,2 x 55
---	-------------

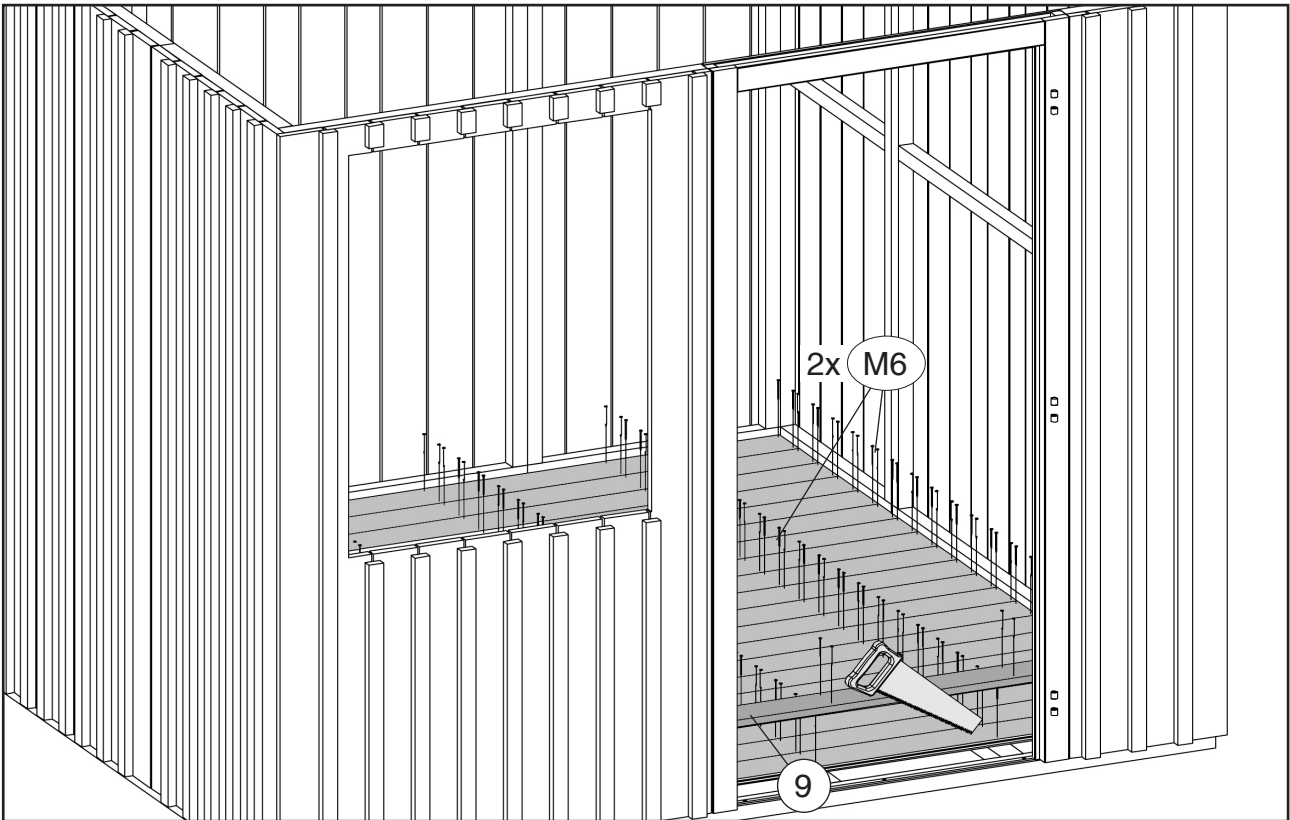

11

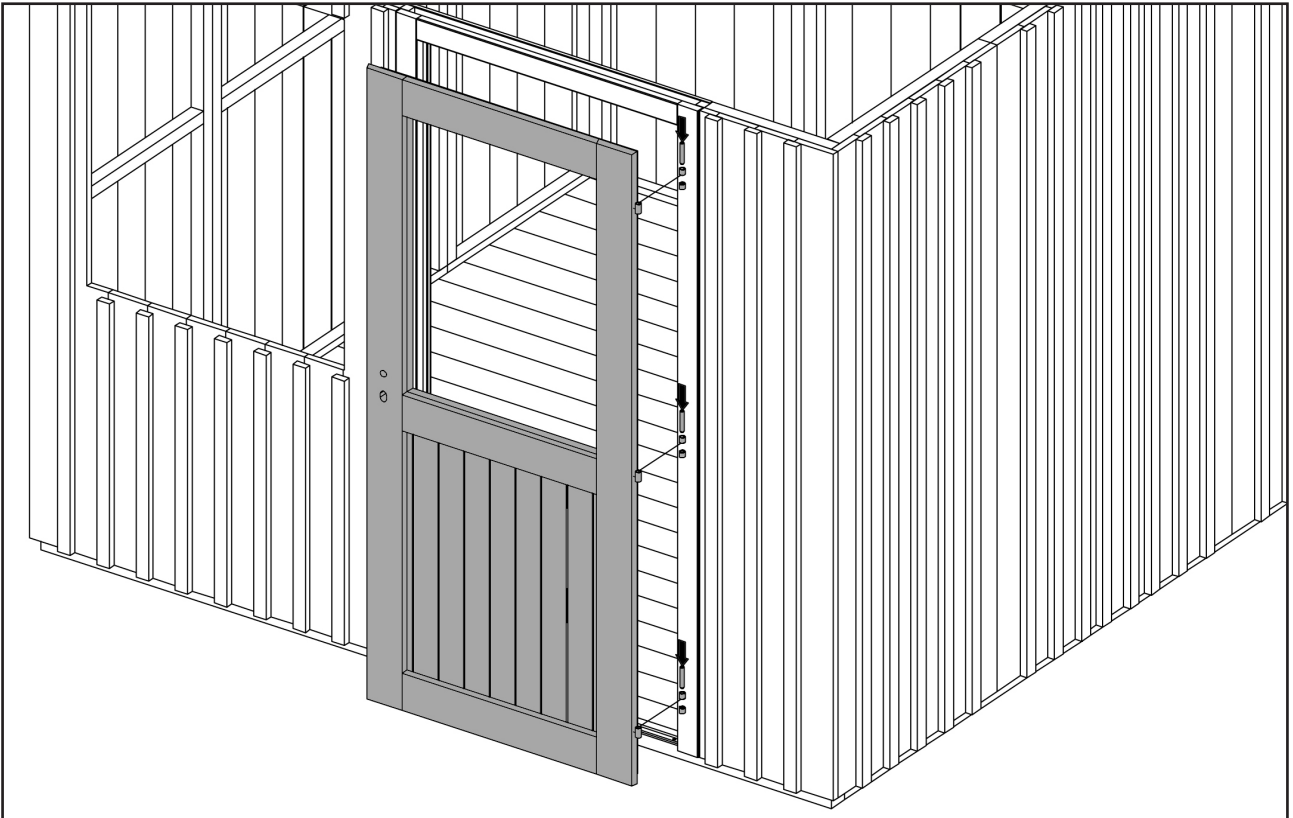

12

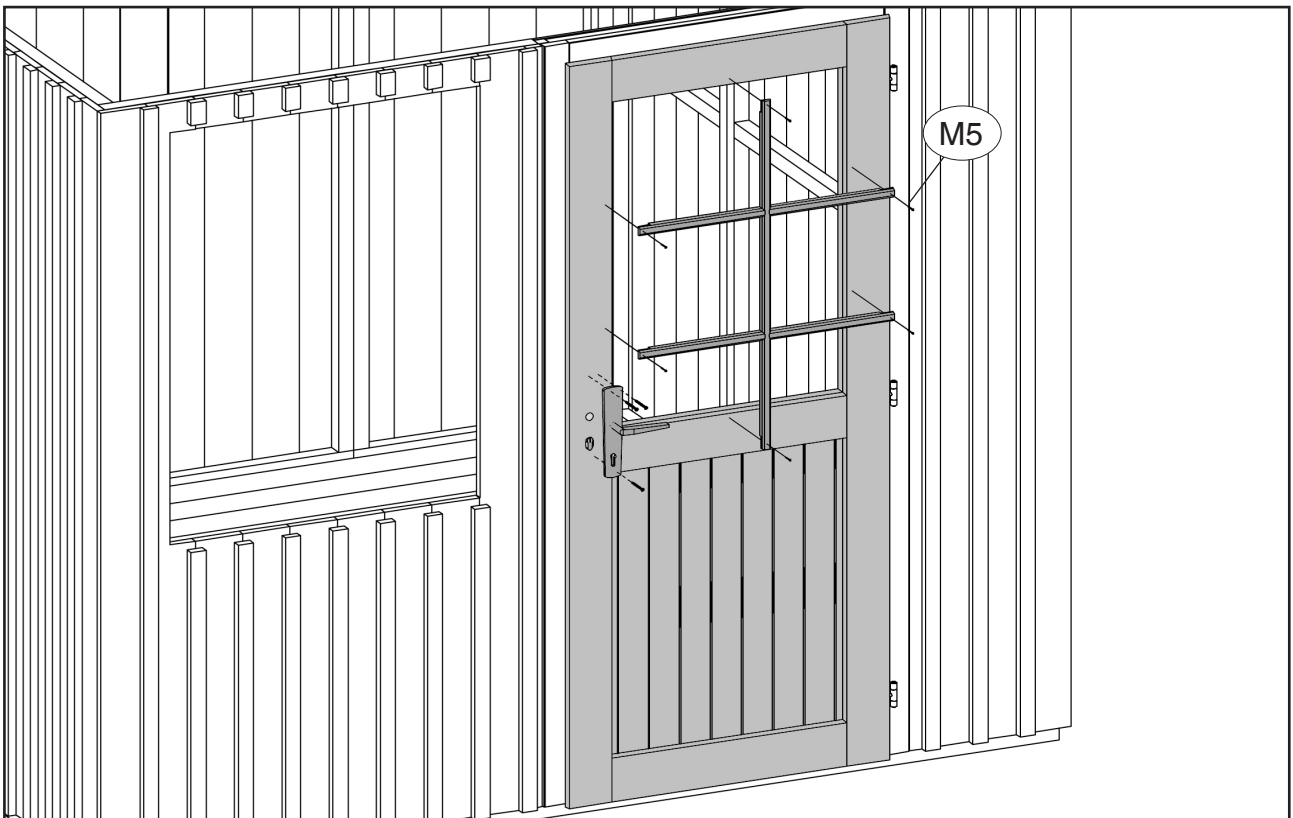
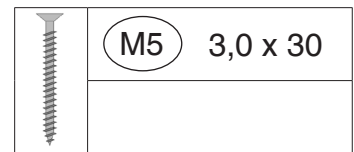

13

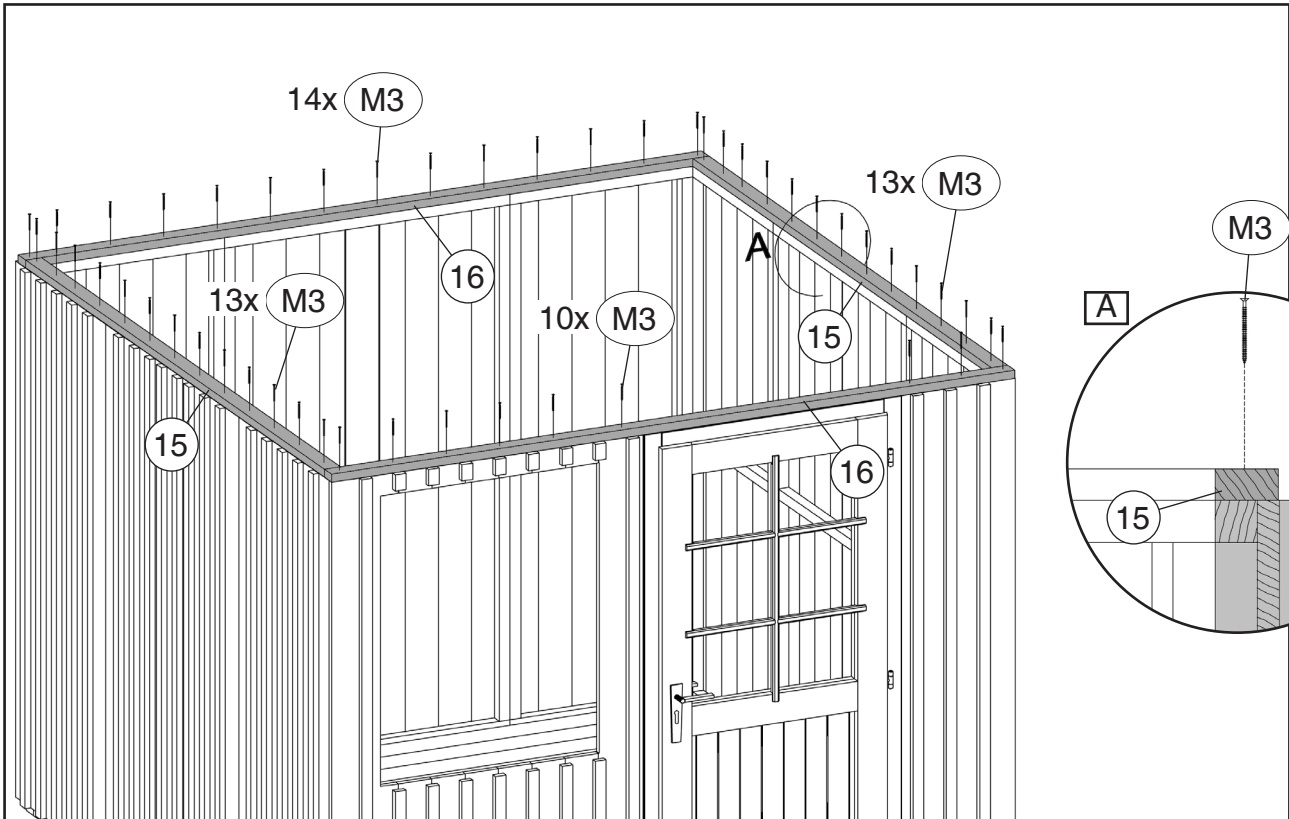
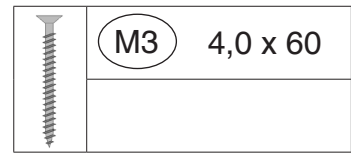

13.1

Draufsicht

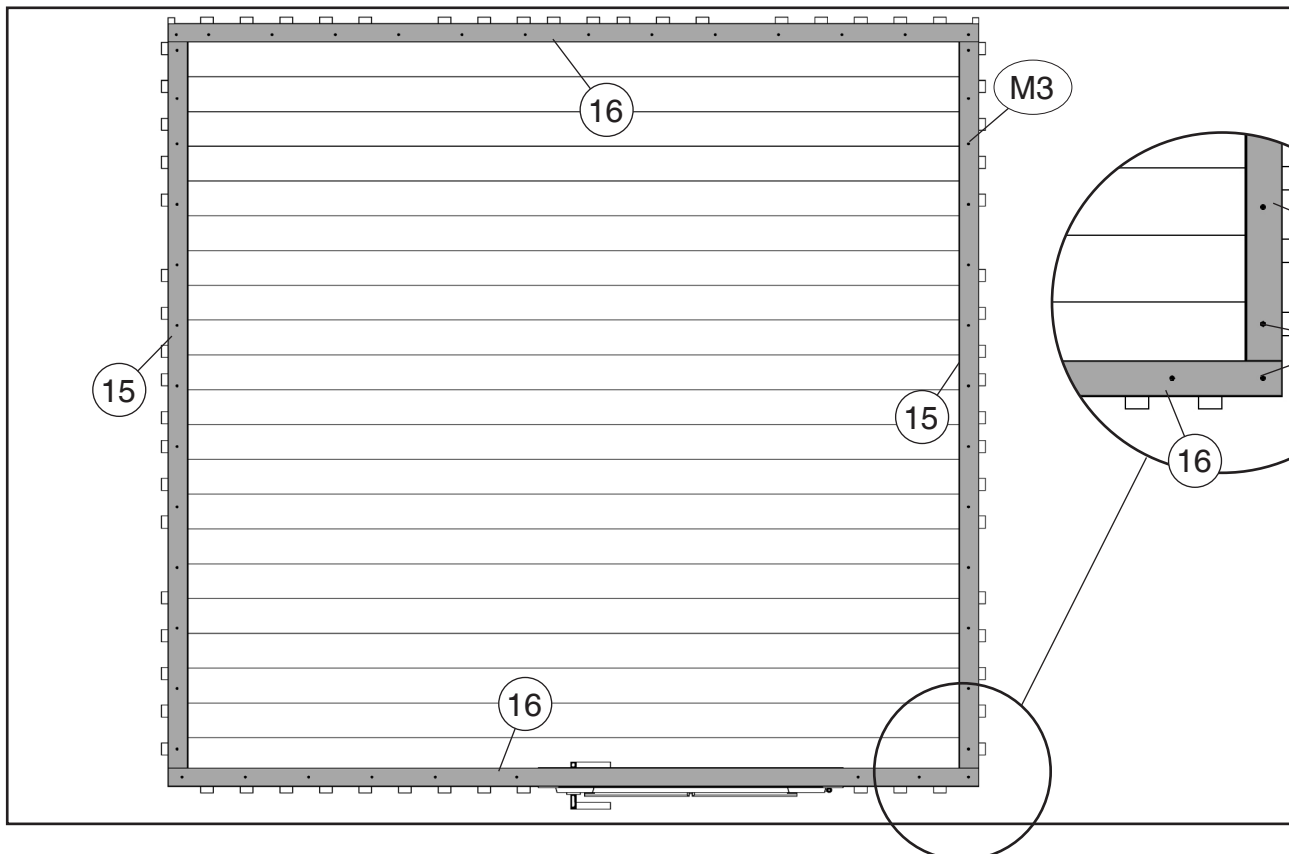
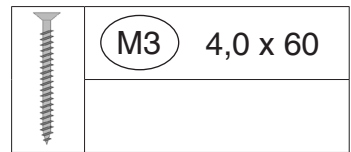

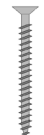

14

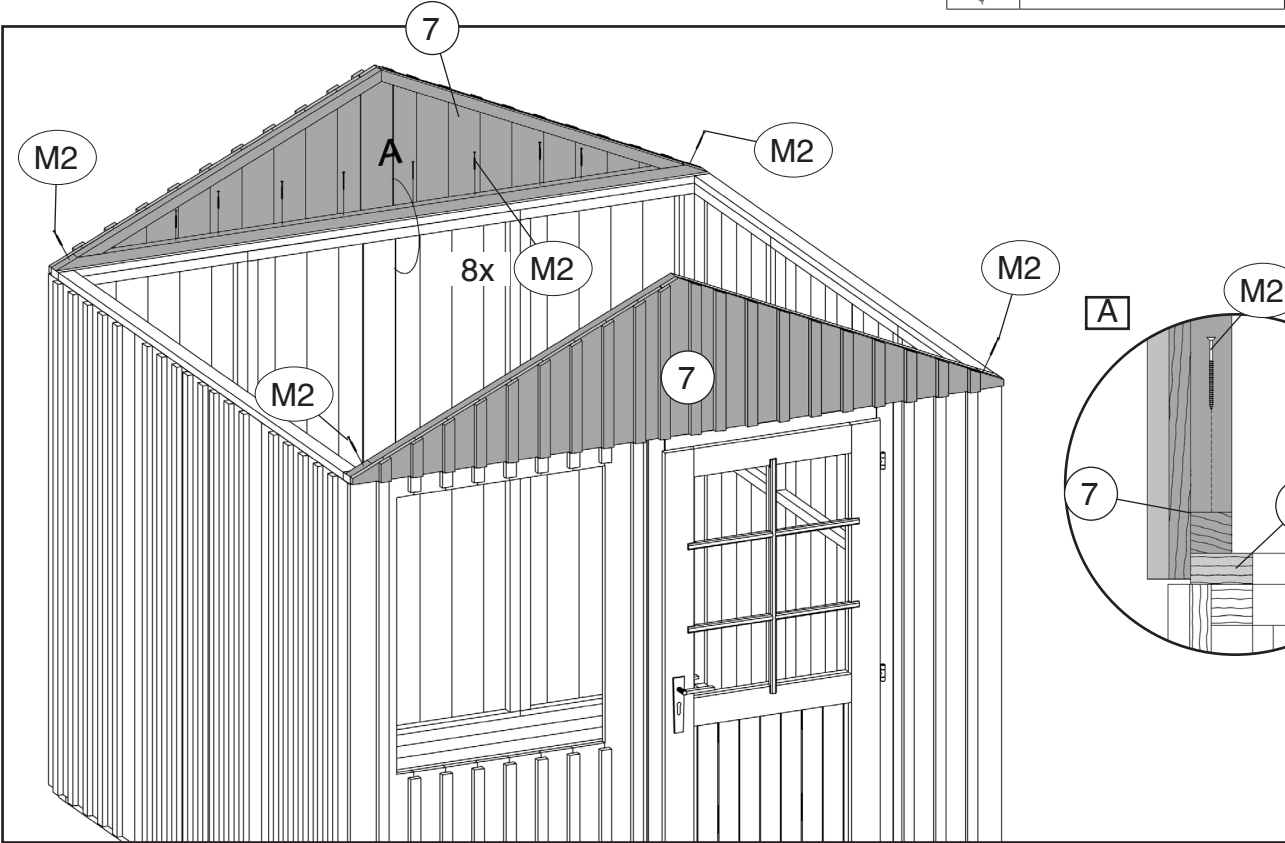
	M2 4,5 x 70
--	-------------

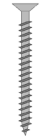

15

	M3 4,0 x 60
	M4 4,0 x 40

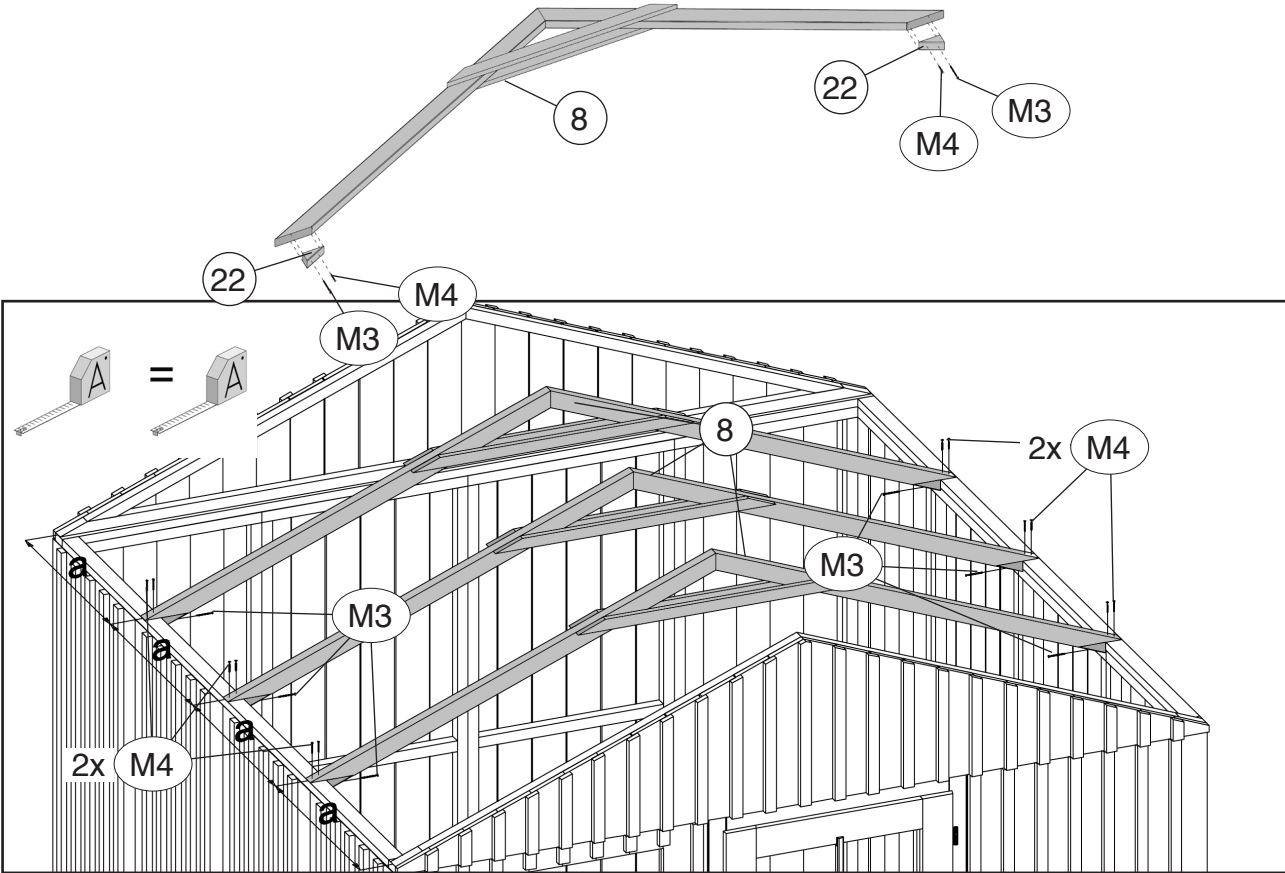

16

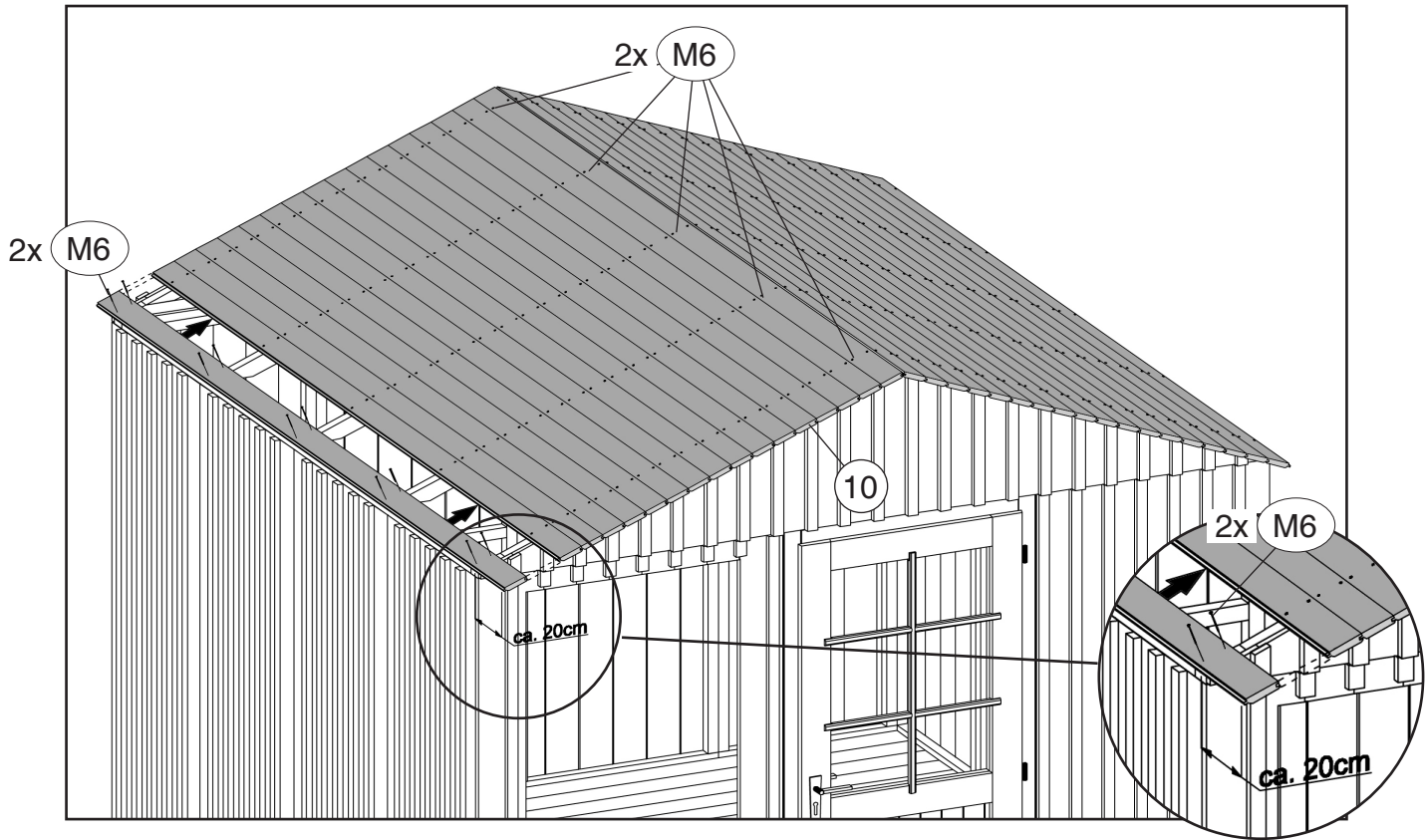

17

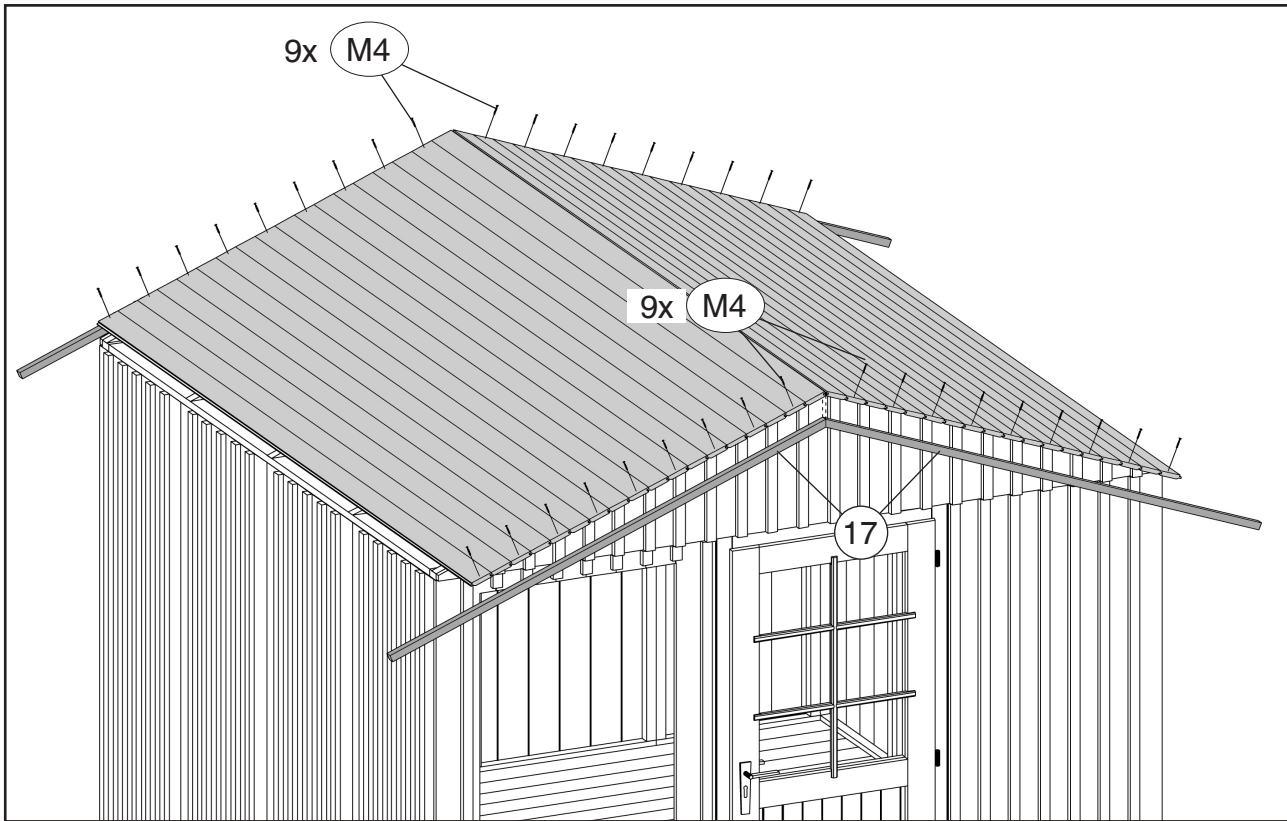
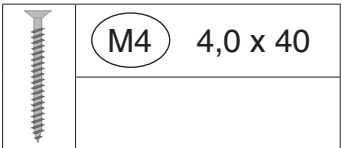



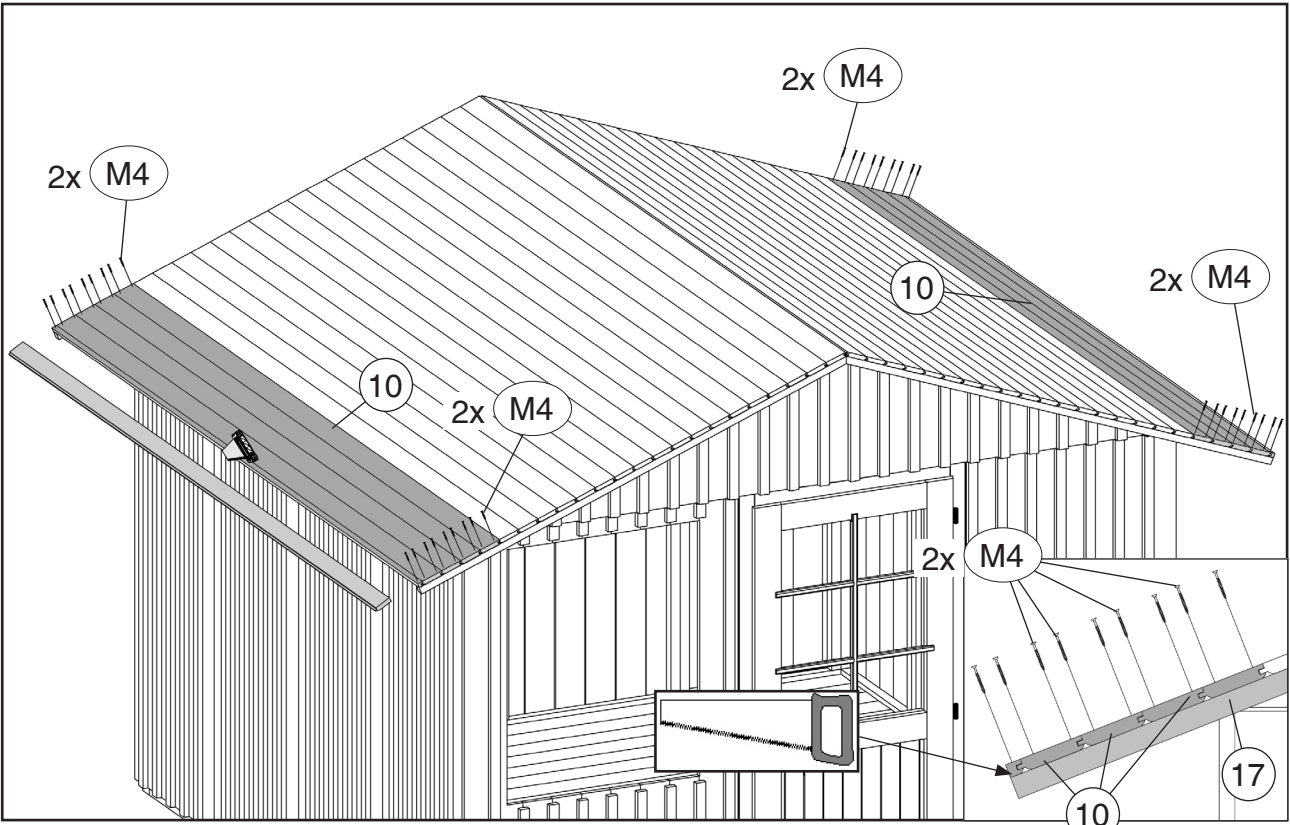
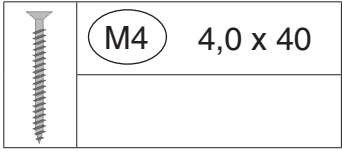

18

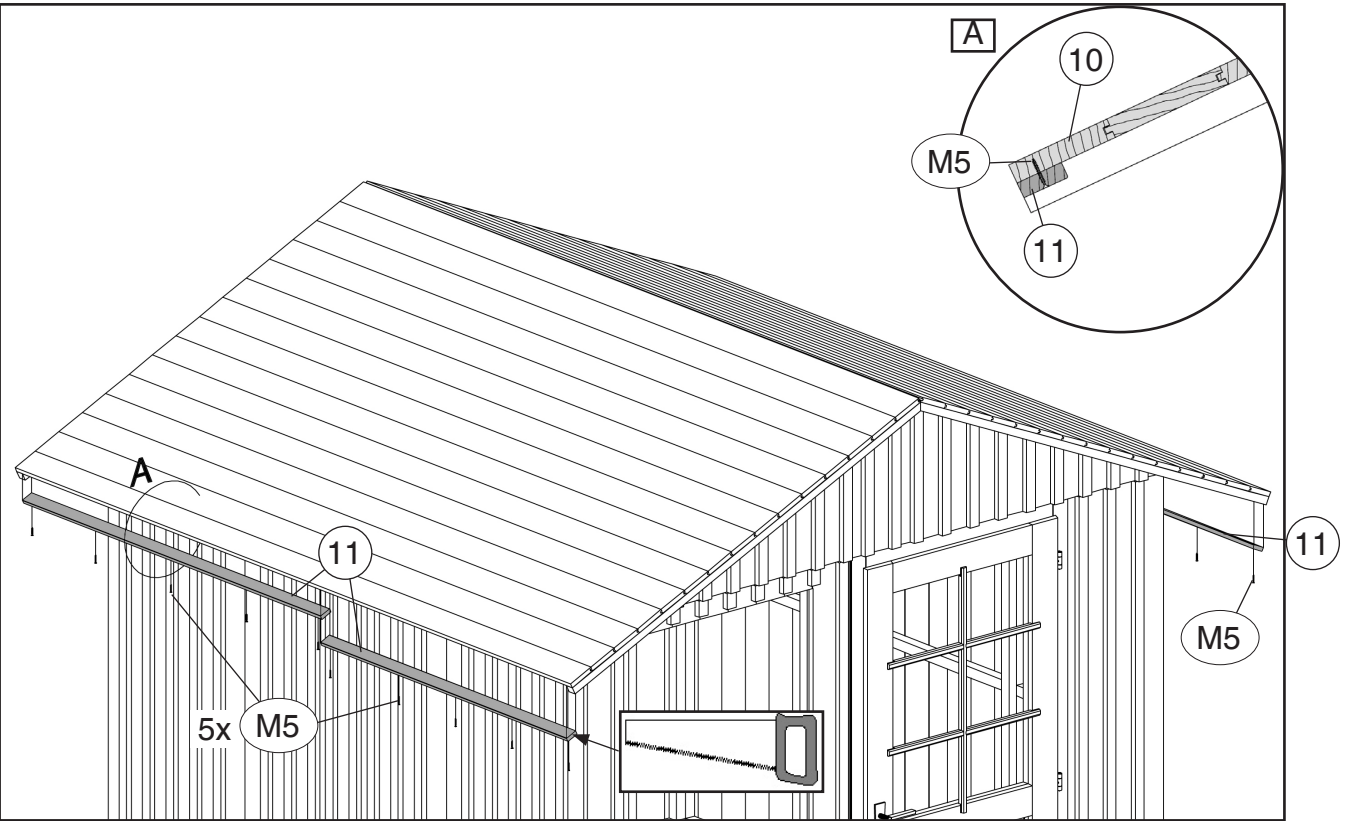
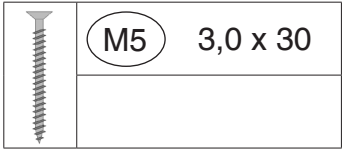

19



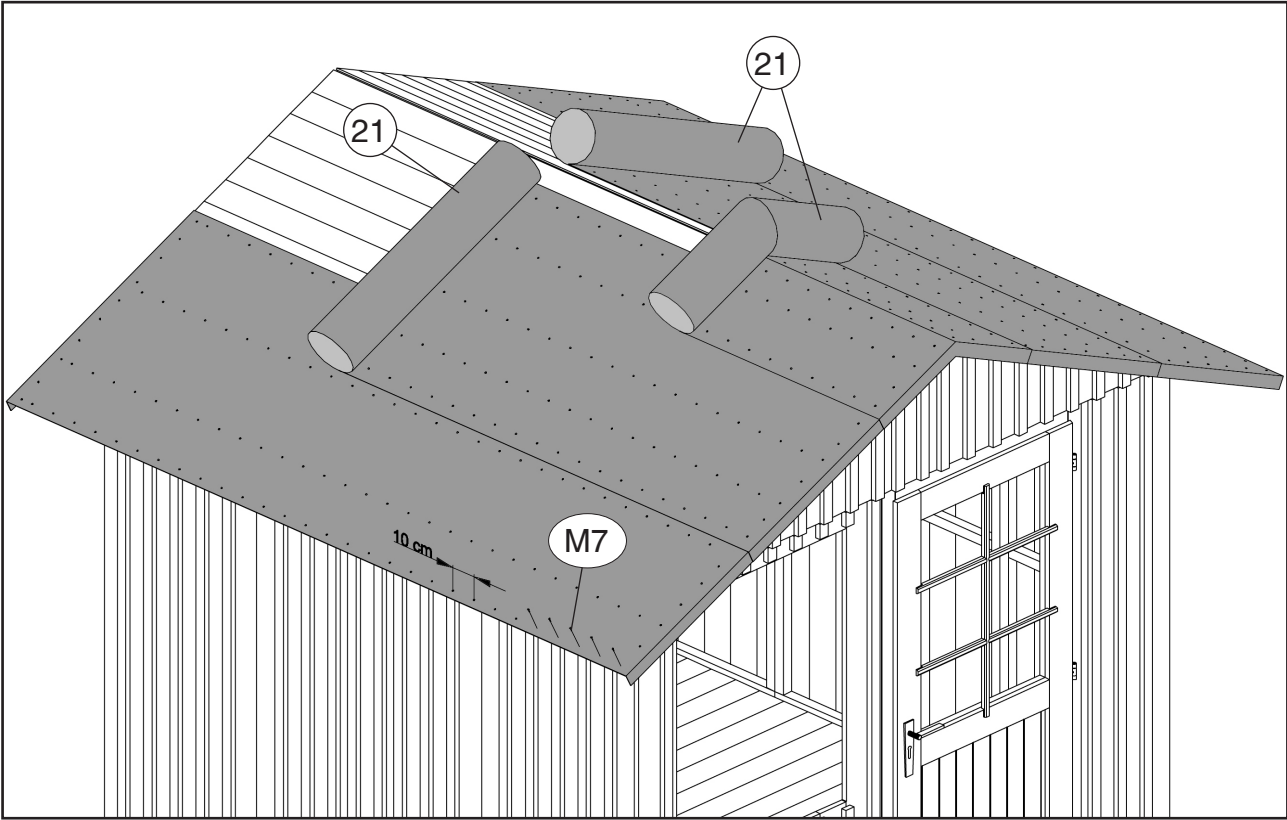

20

	M7	2,0 x 13



21

	M10	
	M11	2,2 x 9,5

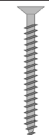
	M5	3,0 x 30

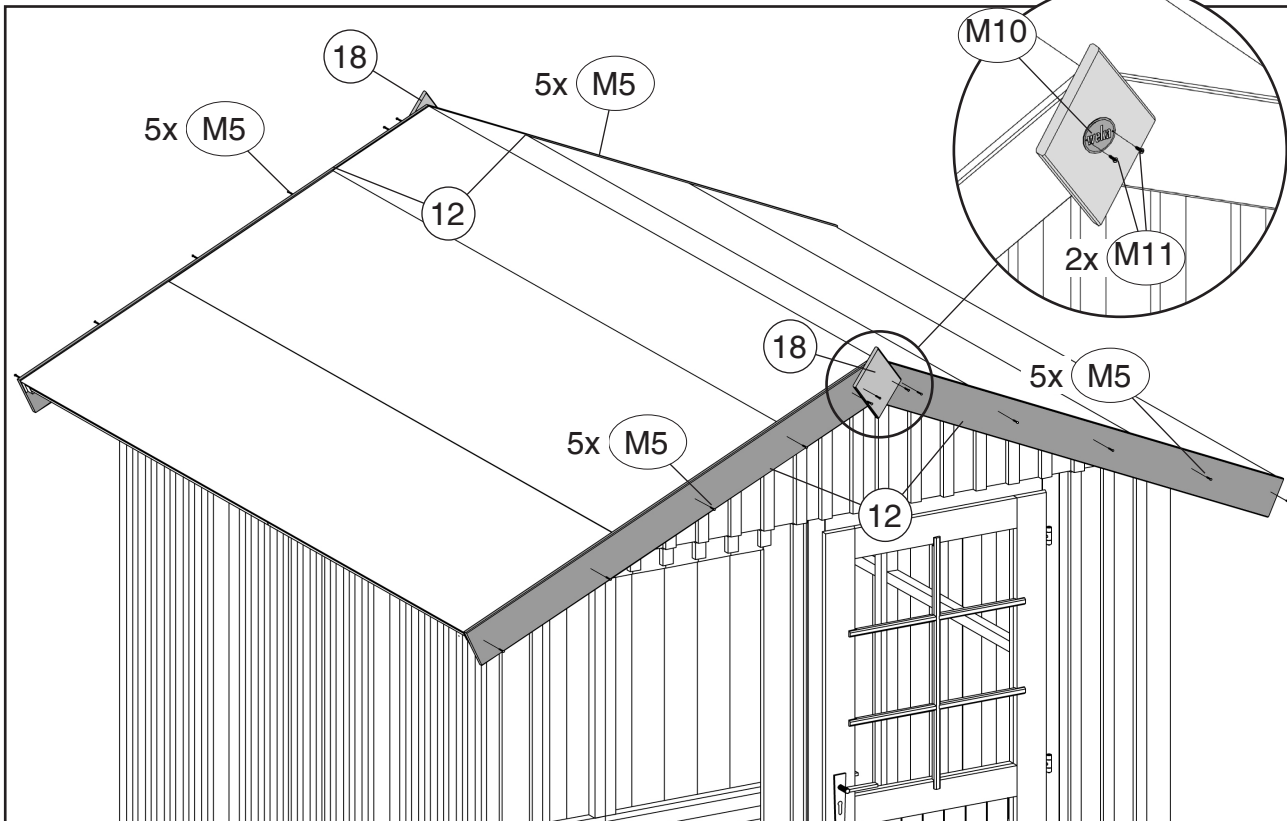

22

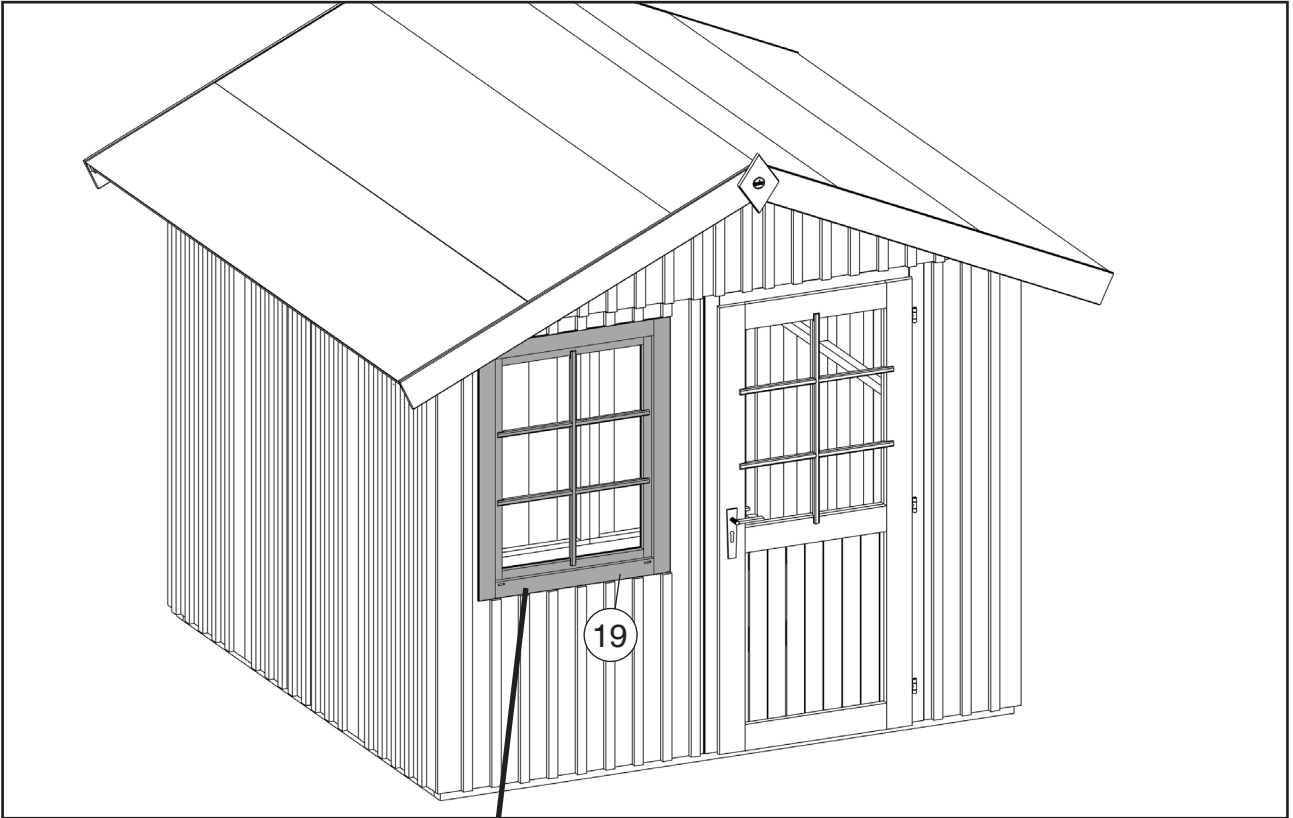

22.1

22.2

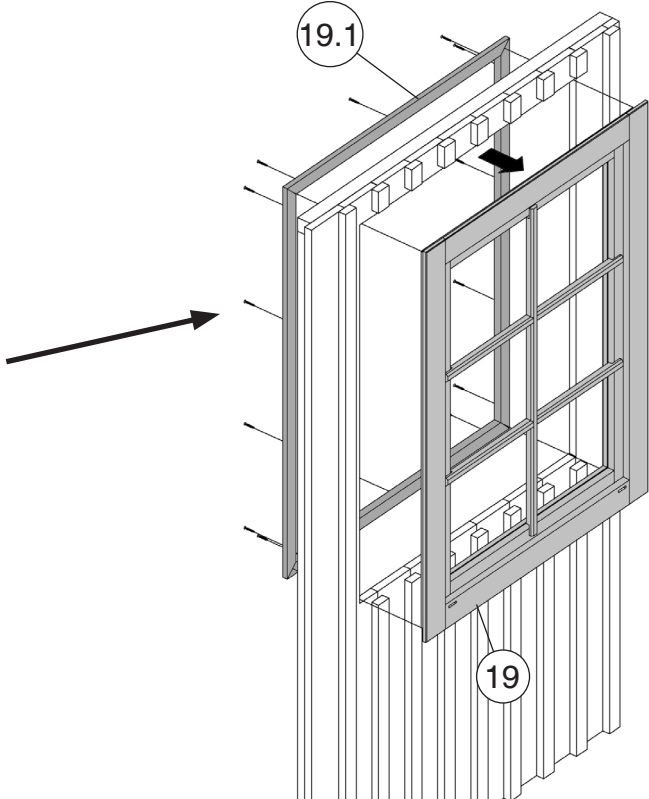
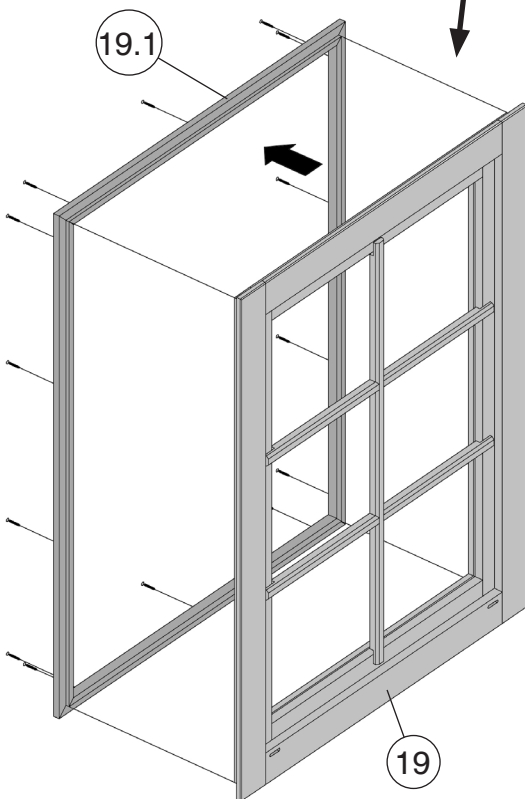

23

	M4 4,0 x 40
--	-------------

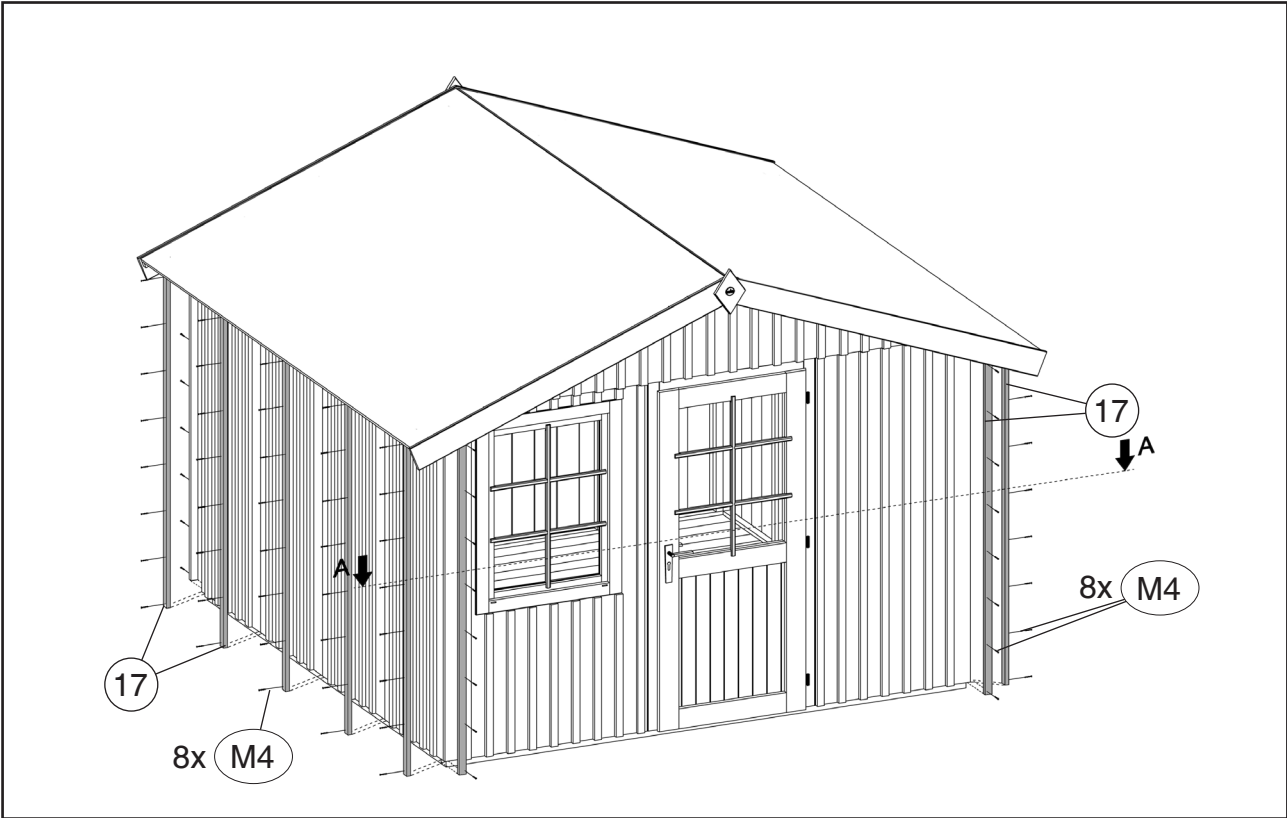

23.1

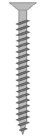
	M2 4,5 x 70
---	-------------

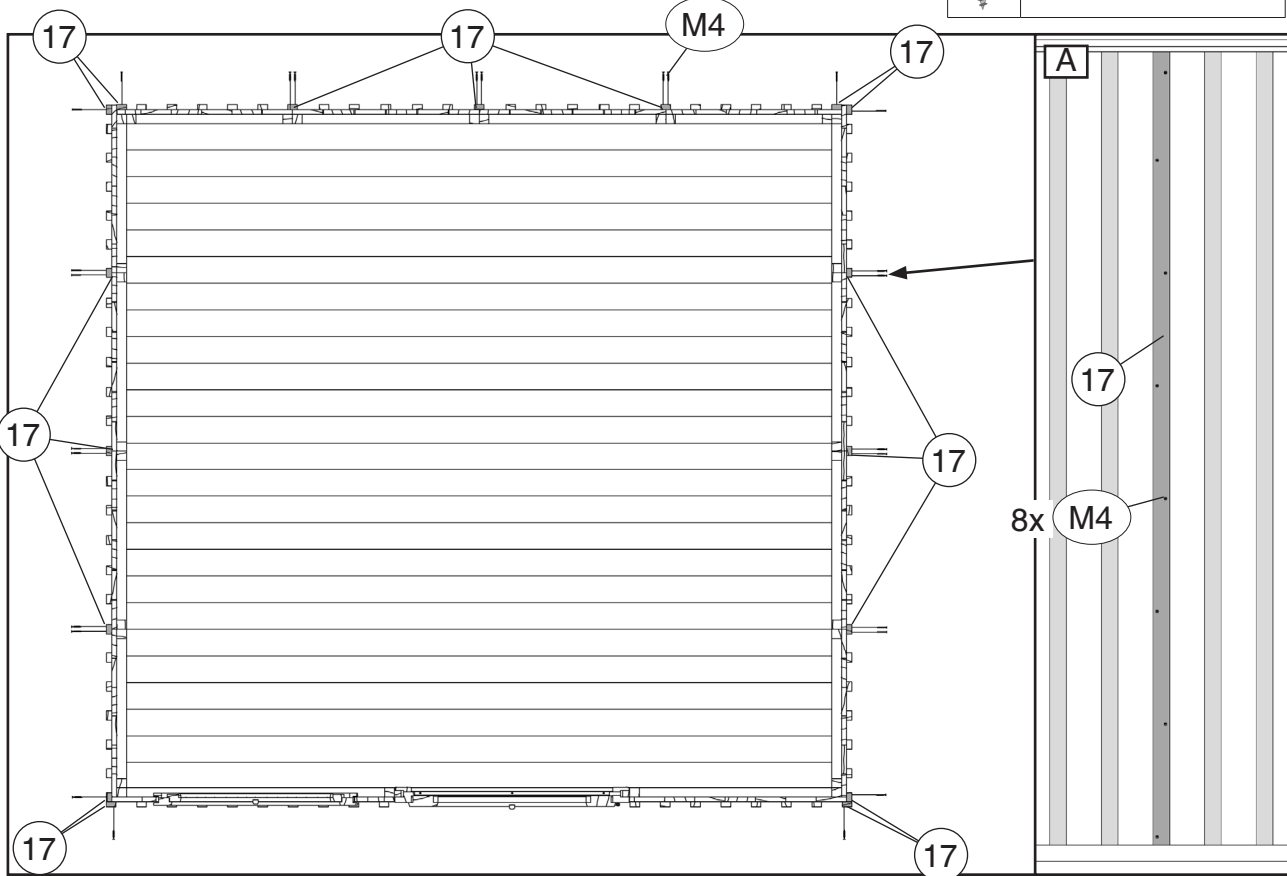

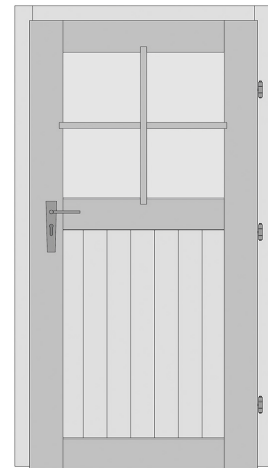
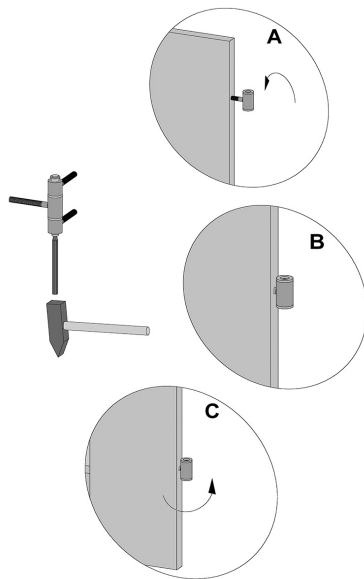
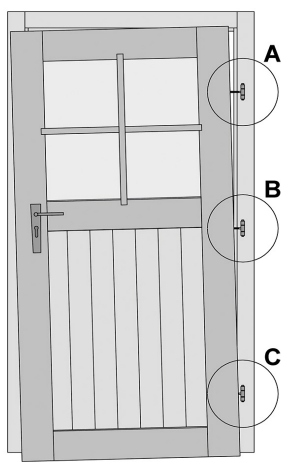
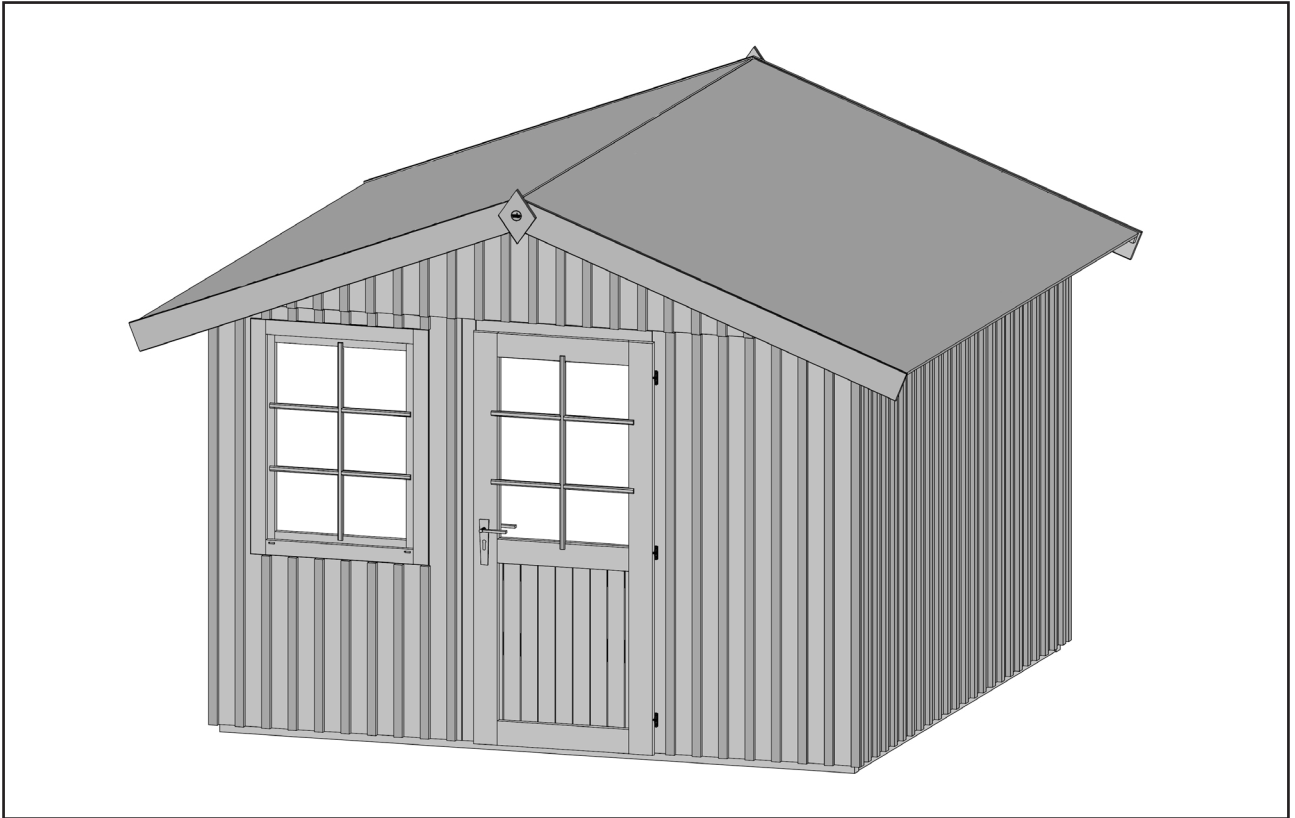





# Kennen Sie schon die WEKA- Wellnesswelt?



Jetzt  
scannen  
und unsere  
**Saunen &  
Infrarotkabinen**  
entdecken!



[www.weka-holzbau.com](http://www.weka-holzbau.com)

**weka**

**WEKA Holzbau GmbH**

Johannesstr. 16, 17034 Neubrandenburg

Tel.: +49 (0)395 42908-0

Fax: +49 (0)395 42908-83

Mail: [info@weka-holzbau.com](mailto:info@weka-holzbau.com)

Web: [www.weka-holzbau.com](http://www.weka-holzbau.com)

MA Art.-Nr.: 800.0286.17.81

© Copyright HRB 3662